

**MULTIFUNCTIONAL DIGITAL COLOR SYSTEMS /
MULTIFUNCTIONAL DIGITAL SYSTEMS**

Fax

e-STUDIO2020AC/2520AC/2021AC/2521AC

e-STUDIO2525AC/3025AC/3525AC/4525AC/5525AC/6525AC

e-STUDIO2528A/3028A/3528A/4528A/5528A/6528A

e-STUDIO6526AC/6527AC/7527AC

e-STUDIO6529A/7529A/9029A



Preface

Thank you for purchasing our product.
This Operator's Manual describes how to use the fax functions and perform maintenance, etc.
Read this manual before using the functions.

■ How to read this manual

□ Symbols in this manual

In this manual, some important items are described with the symbols shown below. Be sure to read these items before using this equipment.

 WARNING	Indicates a potentially hazardous situation which, if not avoided, could result in death, serious injury, or serious damage, or fire in the equipment or surrounding objects.
 CAUTION	Indicates a potentially hazardous situation which, if not avoided, could result in minor or moderate injury, partial damage to the equipment or surrounding objects, or loss of data.
Note	Indicates information to which you should pay attention when operating the equipment.
Tip	Describes handy information that is useful to know when operating the equipment.
	References describing items related to what you are currently doing. See these references as required.

□ Description of original/paper direction

Paper or originals of A4, B5 or LT size can be placed either in a portrait direction or in a landscape direction. In this manual, “-R” is added to this paper size when this size of paper or original is placed in a landscape direction.

Example: A4 size original on the original glass

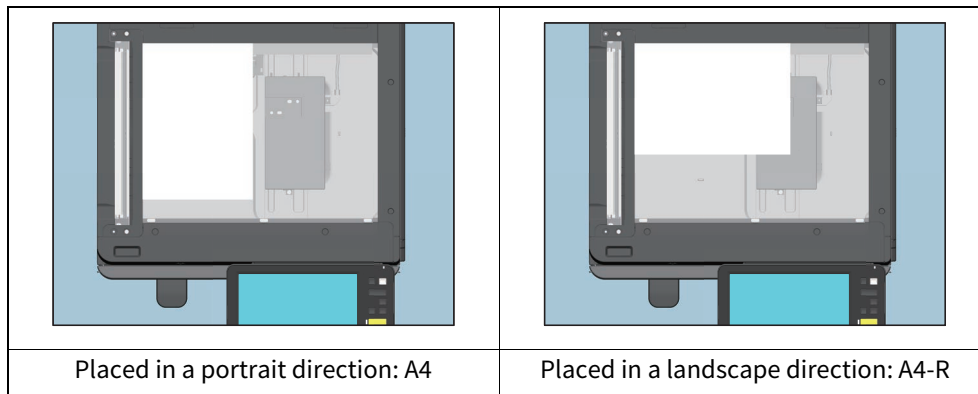

Paper or originals of A3, B4, LD or LG can only be placed in a landscape direction, therefore “-R” is not added to these sizes.

□ Model and series names in this manual

In this manual, each model name is replaced with the series name as shown below.

Model name	Series name
e-STUDIO2020AC/2520AC/2021AC/2521AC	e-STUDIO6525AC Series
e-STUDIO2525AC/3025AC/3525AC/4525AC/5525AC/6525AC	
e-STUDIO2528A/3028A/3528A/4528A/5528A/6528A	e-STUDIO6528A Series
e-STUDIO6526AC/6527AC/7527AC	e-STUDIO7527AC Series
e-STUDIO6529A/7529A/9029A	e-STUDIO9029A Series

❑ Optional equipment

For available options, see the reference below:

Information About Equipment - Information About Equipment - Options

❑ Screens in this manual

- In this manual, Windows 10 is taken for explanation purposes to describe the screens and operation procedures in Windows.
- The details on the screens may differ depending on your model and how the equipment is used, such as the status of the installed options, the OS version and the applications.
- The illustration screens used in this manual are for paper in the A/B format. If you use paper in the LT format, the display or the order of buttons in the illustrations may differ from that of your equipment.

❑ Abbreviations in this manual

In this manual, “Dual Scan Document Feeder”(DSDF) and “Reversing Automatic Document Feeder”(RADF) are collectively referred to as “Automatic Document Feeder”(ADF). In this manual, “Dual Scan Document Feeder” is referred to as “DSDF” and “Reversing Automatic Document Feeder” as “RADF”.

❑ Trademarks

For trademarks, refer to the **Safety Information**.

■ Features and Functions

Installing the FAX unit in this equipment will make the following fax functions usable.

- Fax function
Faxes can be sent and received by using a phone line.
- Network Fax function
The Network Fax features can simplify and facilitate your office facsimile needs and enables you to send fax or Internet Fax digital documents directly from your computer.
Installing the highly intuitive, network N/W-Fax driver software enables you to send fax or Internet Fax digital documents from your computer to one or more recipients.

CONTENTS

Preface	3
How to read this manual	3
Features and Functions	4

Chapter 1 BEFORE USING FAX

Description of Each Component	10
Control panel	10
Touch panel.....	10
Options	11
Simple Fax	11
Connecting Cables	12

Chapter 2 USING THE FAX UNIT (BASIC OPERATION)

Operating the Fax unit	14
Placing an original	14
Sending a Fax	19
Setting the transmission conditions	21
Specifying the recipient.....	27
Displaying the preview before sending a fax.....	32
On-hook transmission/Off-hook transmission	34
Receiving a Fax	36
Originals and paper	36
Reception mode.....	39
Checking Communication Status	42
Checking reserved transmissions	42
Checking communication log	43
Canceling the Transmission	45
Canceling memory transmission job	45
Pausing transmission	47
Canceling reserved transmissions	47

Chapter 3 USING THE FAX UNIT (USEFUL FUNCTIONS)

Prioritizing Transmissions (Priority Reserve)	50
Communicating to a Request from a Recipient (Polling Communication)	51
Storing data of originals in the memory (polling transmission).....	51
Requesting to send data of originals (polling reception)	52
Using the Mailbox Function	53
Registering, printing, and deleting originals (mailbox transmission).....	54
Sending and retrieving originals (mailbox transmission).....	57
Creating, modifying, and deleting a mailbox (mailbox transmission)	59
Dialing numbers by Chaining Multiple Sets of Numbers (Chain Dial Communication)	64
Sending Faxes at Specified Dates and Times (Delayed Transmission Reservation)	65
Resending Unsent Data (Recovery Transmission)	66
E-mailing Data Received Via the Mailbox (Onramp Gateway)	67
Sending Data Received by E-mails Via the Mailbox (Offramp Gateway)	68
Saving Transmitted Fax Data to the Shared Folder	69
Specifying the network folder	71

Printing Secure Receive fax jobs	73
Printing Lists and Reports	75
Printing Lists & Reports Manually	75
Printing Lists & Reports Automatically	77

Chapter 4 USING N/W-FAX DRIVER (NETWORK FAX)

Overview of the Network Fax Features	80
Sending Network Faxes	81
When password entry is required	82
When LDAP authentication is enabled	83
Specifying Recipients of Network Faxes	84
Entering recipients from the keyboard	84
Selecting recipients from the address book	86
Selecting recipients from the address book (Search option)	87
Removing recipients	92
Setting up the N/W-Fax Driver	93
Making the initial settings of the N/W-Fax driver options	93
Setting print options for each print job	93
Setting up the N/W-Fax Driver Options	94
Setting up the [Layout] tab	94
Setting up the [Send] tab	95
Setting up the Cover Sheet	97
Setting up the SNMP	98
Setting up the [Device Settings] tab	100
Customization: [Language] tab	102
Setting up LDAP servers	103
Sending With Extended Fax Functionality	104
Saving a fax as a file	104
Delayed transmission reservation	105
Sending with a cover sheet	106

Chapter 5 USING THE INTERNET FAX

Internet Fax Features	112
Precautions for Internet Fax Transmissions	113
Sending Internet Faxes	114
Sending Internet faxes	114
Setting advanced functions	115
Saving data sent in a file along with internet fax transmission	115
Receiving Internet Faxes	116
Available file formats	116
Receiving Internet faxes	116

Chapter 6 PRINTING LISTS AND REPORTS

TRANSMISSION JOURNAL	118
RECEPTION JOURNAL	120
RESERVATION LIST	122
MAILBOX/RELAY BOX REPORT	123

MEMORY TRANSMISSION REPORT	124
TRANSMISSION REPORT.....	125
MULTI TRANSMISSION REPORT.....	126
MULTI POLLING REPORT	127
RELAY TX ORIG. TERMINAL REPORT.....	128
RELAY TX RELAY STATION REPORT	129
RELAY TX END TERMINAL REPORT	130
RELAY STATION REPORT	131
MAILBOX RECEPTION REPORT	132
INDEX	133

BEFORE USING FAX

Description of Each Component	10
Control panel	10
Touch panel.....	10
Options.....	11
Simple Fax.....	11
Connecting Cables	12

Description of Each Component

Control panel

For details of the buttons on the control panel, see the reference below:

Information About Equipment - Information About Equipment - Description of Components - Control Panel

Touch panel

This section describes the fax screen on the touch panel.

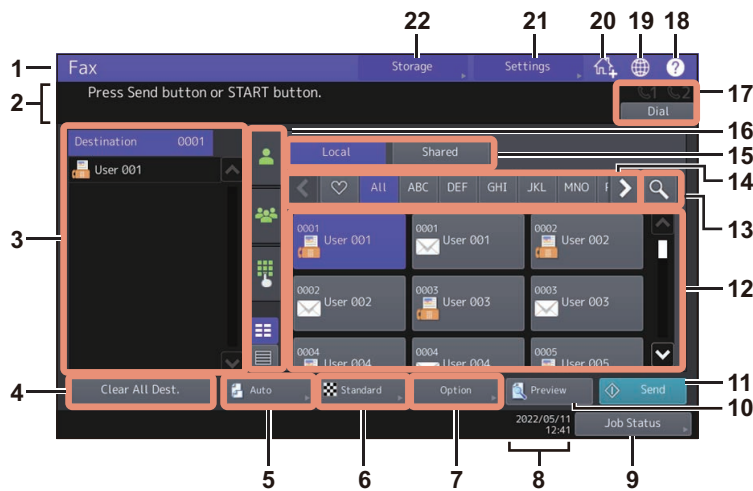

1. Function display
The function being used is displayed.
2. Message indication area
This shows a brief description of the functions or the current status of this equipment in message form.
3. Destination indication area (📖 P.27)
The number of the selected recipients and their names are displayed.
4. [Clear All Dest.] button (📖 P.31)
This is to clear all the displayed recipients in the destination indication area.
5. Original size setting button (📖 P.22)
This is to set the original size.
6. Resolution setting button (📖 P.23)
This is to set the resolution when scanning an original.
7. Option setting button (📖 P.24)
This is to set the option.
8. Date and time
The current date and time are shown here.
9. [Job Status] button (📖 P.36)
This is to view the job status or its history.
10. [Preview] button (📖 P.32)
This is to display a preview of a scanned image before the transmission.
11. [Send] button (📖 P.19)
This is to send a fax job.
12. Address indication area (📖 P.28)
The recipients registered in the address book are displayed. For details of the registration to the address book, see the references below:
TopAccess - [Registration] - [Registration] Overview - [Address Book] Item list
User Functions - SETTING ITEMS (User) - Address - Managing contacts in address book - Creating new contacts
- Note**
When an individual recipient is selected from the address book, confirm that the selected one is displayed on the recipient list on the left side of the screen.
13. Search button (📖 P.28)
This is to search the recipients.

14. Favorite/index buttons

This is to refine the recipients registered in the address book. When you press , only the recipients registered in the favorite are displayed in the address indication area. When you press any of the index buttons, only the applicable recipients registered in each index are displayed in the address indication area.

15. Address book switch buttons

This is to switch the local or shared address book. These buttons are displayed only when the use of the shared address book is available. For details about the shared address book, see the reference below:

TopAccess - [Registration] - [Registration] Overview - [Address Book] Item list

16. Recipient selection method switch tab ( P.27)

This is to switch the selection method of the recipients.

17. On-hook transmission button ( P.34)

This is to perform on-hook transmission.

18. [?](Help) button

This is to view the explanation of each function or the buttons on the touch panel.

19. Language button

This is to switch a language.

20. Adding to Home screen button

This is to add a setting such as a job setting to the Home screen. For details, see the reference below:

Template - REGISTERING JOB SETTINGS ONTO THE HOME SCREEN - Registering Job Settings onto the Home Screen

21. [Settings] button

This is to check currently set functions.

22. [Storage] button ( P.69)

This is for the storage function.

Tip

When this equipment is managed under the department management or user management, key in user information such as the department code, user name and password to display the operation screen. For details of the operation, see the reference below:

Information About Equipment - Information About Equipment - Logging in

Options

This section describes the options related to the fax function.

- **FAX Unit**

This unit enables the use of the fax function. Two fax units can be installed in one piece of equipment at a maximum. Install two fax units if you want to send/receive faxes using 2 lines.

Note

The 2nd line for FAX Unit is not available to some models.

Simple Fax

The equipment provides an independent menu called “Simple Fax” so that you can send faxes with minimum operations.

To learn how to use the menu, see the reference below.

Basic Operation - Simple Fax

Connecting Cables

Be sure that the power of the MFP is turned OFF before connecting the cables.

e-STUDIO6525AC Series / e-STUDIO6528A Series

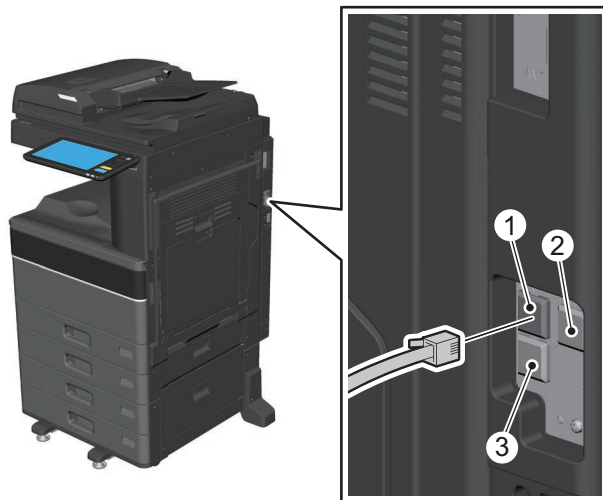

e-STUDIO7527AC Series/ e-STUDIO9029A Series

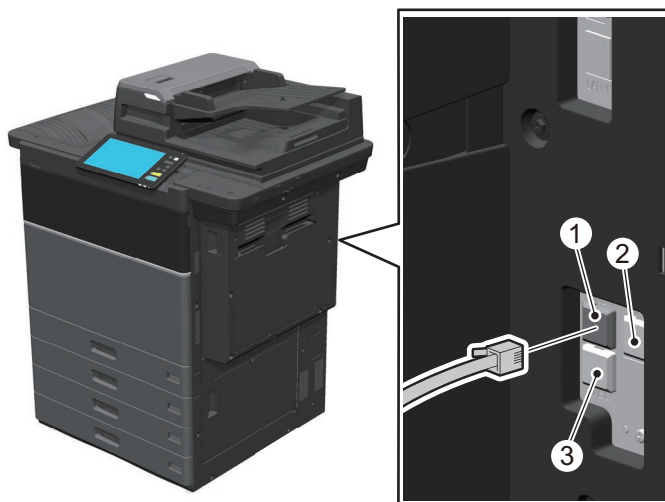

1. LINE
Connect a public network line.
2. LINE2
Connect a public network line when multiple fax units are installed.

Tip

LINE2 is not available to some models.

3. TEL
Connect an external telephone.

Note

- Do not connect the cable for a public network line into the TEL. Otherwise, the MFP may malfunction.
- Do not connect the MFP and the external telephone to a public network line in parallel.
- Use the external telephone without an answerphone (or with the function off) to be connected with the TEL.

USING THE FAX UNIT (BASIC OPERATION)

Operating the Fax unit	14
Placing an original	14
Sending a Fax	19
Setting the transmission conditions.....	21
Specifying the recipient.....	27
Displaying the preview before sending a fax.....	32
On-hook transmission/Off-hook transmission	34
Receiving a Fax	36
Originals and paper	36
Reception mode.....	39
Checking Communication Status	42
Checking reserved transmissions	42
Checking communication log	43
Canceling the Transmission.....	45
Canceling memory transmission job	45
Pausing transmission	47
Canceling reserved transmissions	47

Operating the Fax unit

■ Placing an original

□ Originals that can be sent

Operating the Fax unit, you can send a fax of the following originals.

You can place 1-sided or 2-sided originals of media types, such as plain paper, recycled paper and paper having holes (2, 3 or 4 holes) for filing, on the RADF (Reversing Automatic Document Feeder) or DSDF (Dual Scan Document Feeder). When the original glass is used, originals such as overhead transparencies, tracing paper, booklet or 3-dimensional objects, that cannot be placed on the ADF can be scanned, as well as plain paper.

Location		Maximum size	Paper weight	Original size
Original glass			-	North American format: LD, LG, LT, LT-R, ST, ST-R, COMP A/B format: A3, A4, A4-R, A5, A5-R, B4, B5, B5-R, FOLIO
ADF	RADF	Length: 297 mm (11.69") Width: 432 mm (17.01")	1-sided originals: 35 - 157 g/m ² (9.3 - 41.8 lb.) 2-sided originals: 50 - 157 g/m ² (13.3 - 41.8 lb.)	North American format: LD, LG, LT, LT-R, ST-R, COMP A/B format: A3, A4, A4-R, A5-R, B4, B5, B5-R, FOLIO (ST/A5 is not available)
	DSDF		1-sided originals: 35 - 209 g/m ² * (9.3 - 41.8 lb.) 2-sided originals: 50 - 209 g/m ² * (13.3 - 41.8 lb.)	

* You may not obtain enough image quality when an original with a paper weight of more than 157 g/m² (41.8 lb.) is used.

Note

- Do not place any heavy objects (4 kg/9 lb. or over) on the original glass and do not press on it with force.
- If the original is any of the following sizes, it is automatically rotated and sent as described below. This function is not available to some models.
 - A4 to A4-R
 - A5-R to A5
 - B5-R to B5
 - LT to LT-R
 - ST-R to ST
- You need to select the original size by yourself when placing the following originals whose sizes cannot be detected correctly:
 - Highly transparent originals (e.g. overhead transparencies, tracing paper)
 - Totally dark originals or originals with dark borders
 - Non-standard size originals (e.g. newspapers, magazines)

❑ Original scanning range

The following figures show the original scanning area. Any information in the shaded area is not printed on the paper.

1. LD, LG, LT-R, ST-R, COMP, A3, A4-R, A5-R, B4, B5-R, FOLIO
2. LT, ST, A4, A5, B5

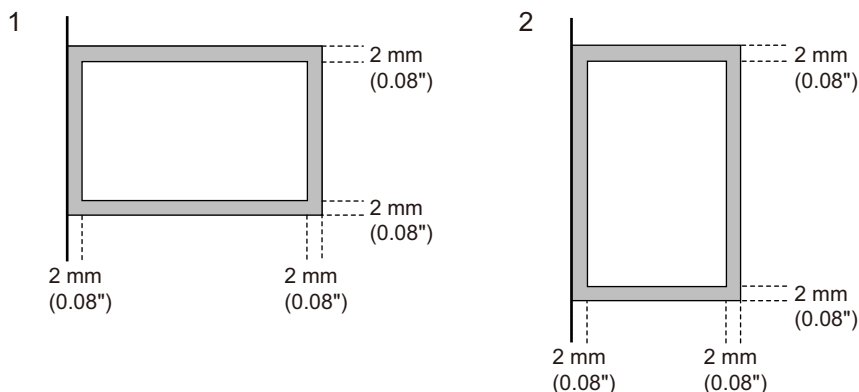

❑ Placing the original(s) on the original glass

This section describes how to set an original on the original glass. Originals are sent in the order they are placed on the original glass.

- 1** Raise the original cover or ADF, and place the original with its face down.

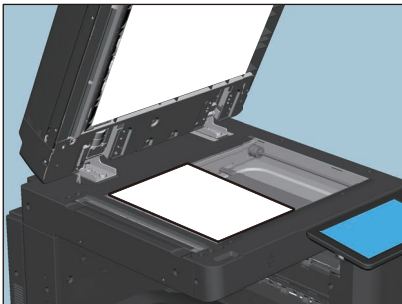

Raise it at least 60 degrees to allow the original to be detected appropriately. You need to set the size of the original manually to some models.

- 2** Align the original against the left inner corner of the glass.

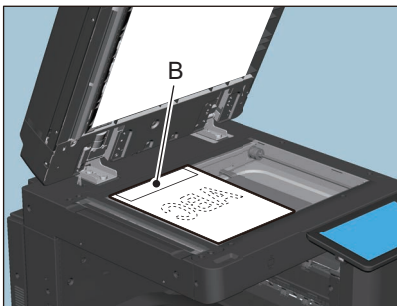
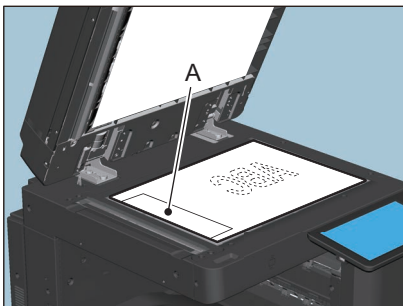

- Different size originals can also be sent in one transmission.
- When an original of any size other than LT/A4 is placed in the direction shown in the above left-hand figure, transmission to a recipient is carried out so that the pre-entered sender information is printed in position A in the figure.
- When an original of LT/A4 size is placed in the direction shown in the above right figure, transmission to a recipient is carried out so that the pre-entered sender information is printed in position B in the figure.
- The contents registered in the Terminal ID or sender name are reflected in the sender information. For details about the registration method of the Terminal ID and sender name, see the reference below:
User Functions - SETTING ITEMS (Admin) - Fax - Registering the terminal ID

3 Lower the original cover or ADF slowly.

□ Placing the original(s) on the ADF

This section describes how to set the original(s) on the ADF. When the originals are placed on the RADF, the uppermost page is the first to be scanned and sent.

1 After aligning the originals, place them with their face up and slide the guides to rest against the edges of the originals.

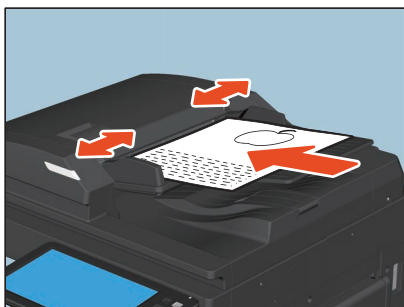

- When the DSDF (Dual Scan Document Feeder) is used:
Regardless of the paper size, originals are acceptable up to 300 sheets (35 to 80 g/m² (9.3 to 20 lb. Bond)) or 38 mm (1.50") in height.
- When the RADF (Reversing Automatic Document Feeder) is used:
Regardless of the paper size, originals are acceptable up to 100 sheets (35 to 80 g/m² (9.3 to 20 lb.)) or 16 mm (0.62") in height.
- 2-sided originals can be set and sent.
 P.21 "Setting the transmission conditions"

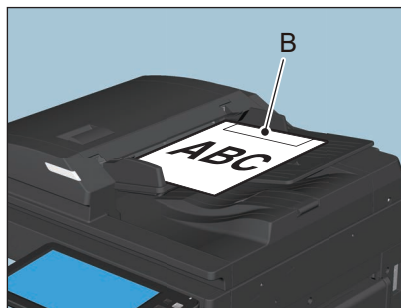
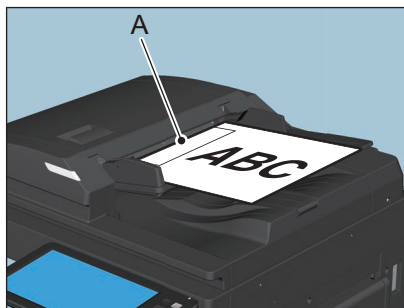

- When an original of any size other than LT/A4 is placed in the direction shown in the above left-hand figure, transmission to a recipient is carried out so that the pre-entered sender information is printed in position A in the figure.
- When an original of LT/A4 size is placed in the direction shown in the above right figure, transmission to a recipient is carried out so that the pre-entered sender information is printed in position B in the figure.
- The contents registered in the Terminal ID or sender name are reflected in the sender information.
For details about the registration method of the Terminal ID and sender name, see the reference below:
User Functions - SETTING ITEMS (Admin) - Fax - Registering the terminal ID

Placing 2-sided originals

To set 2-sided originals of the LT/A4 size, change their direction depending on their bound positions as follows.

1. Right-to-left (book-type) original
2. Top-to-bottom (tablet-type) original

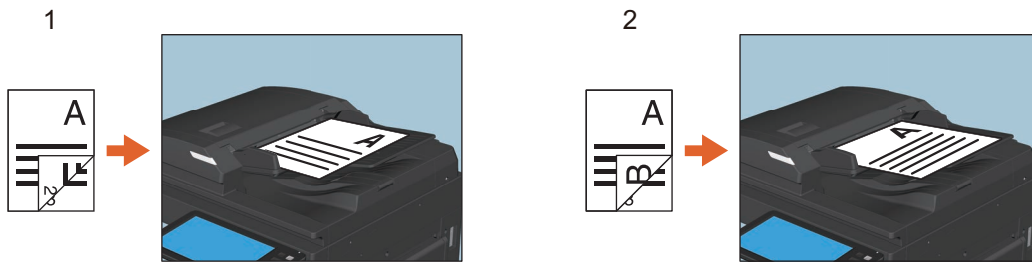

Tip

When sending a 2-sided original, it is necessary to select the 2-sided setting as the transmission condition.

P.21 “Setting the transmission conditions”

Sending different size originals

To set different width originals, adjust the side guides to the widest original size, and then align the original against the front side. Available combinations of the original size are as follows.

- A/B format: A3, A4, B4, B5, A4-R, FOLIO
- North American format: LD, LT, COMP, LG, LT-R

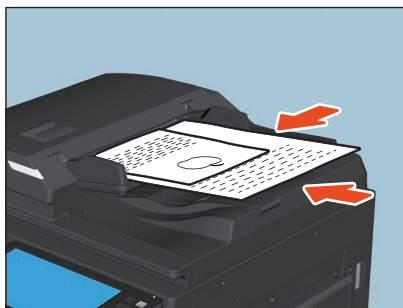

Tip

To send different width originals, you need to enable “Different Width” as a transmission condition.

P.21 “Setting the transmission conditions”

Notes for using the ADF

Do not use the following types of original as they may cause a paper misfeed or damage to the equipment:

1. Originals that are folded or curled
2. Originals with carbon copies
3. Originals that have been taped, pasted, or cut-out
4. Originals with multiple holes punched (e.g. loose leaf paper)
5. Originals that have been clipped or stapled
6. Originals with holes or tears
7. Originals that are damp
8. Originals whose correction fluid or ink has not been dried completely
9. Overhead transparencies or tracing paper
10. Coated paper (e.g. coated with wax)
11. India paper (used for dictionaries, bibles, etc.)

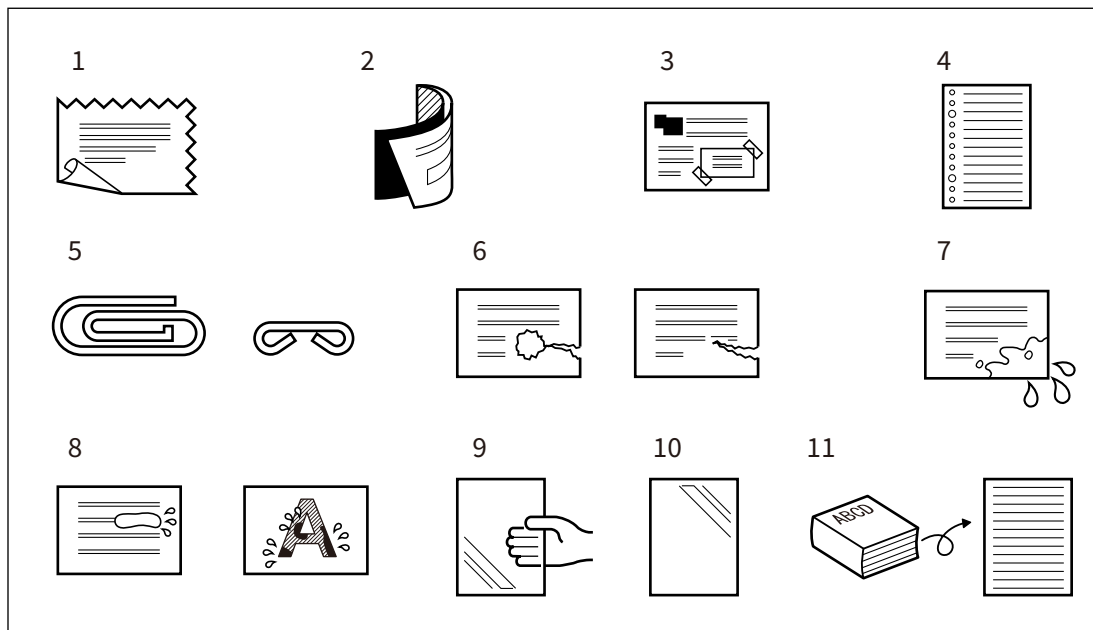

The following types of originals can be used but need extra care:

1. Originals that you cannot slide with your fingers or whose surface is specially treated
They should be fanned well before loading since they may not be able to be separated from each other at feeding.
2. Originals that are folded or curled
They should be smoothed out before being loaded.

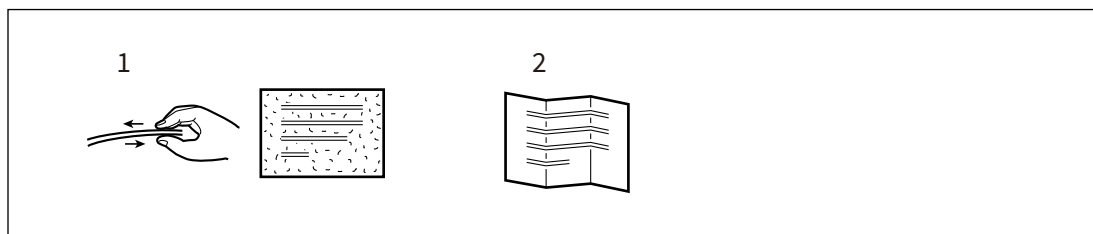

■ Sending a Fax

This section describes the basic procedures to send a fax. For details of in-depth operations, see the section under each procedure as required.

Besides the basic sending functions described in this section, there are various useful ways to send a fax. These procedures are described in the references below:

- 📖 P.34 “On-hook transmission/Off-hook transmission”
- 📖 P.49 “USING THE FAX UNIT (USEFUL FUNCTIONS)”

1 Place the original(s).

Check the original size and scanning range, etc. Place the original(s) in the correct direction on the original glass or ADF.

📖 P.14 “Placing an original”

2 Press [Fax] on the Home screen.

The fax screen is displayed. If you leave the screen unattended for the period of the auto clear setting time (45 sec. by default), the screen returns to the default one automatically.

3 Set the original size, resolution and other necessary conditions.

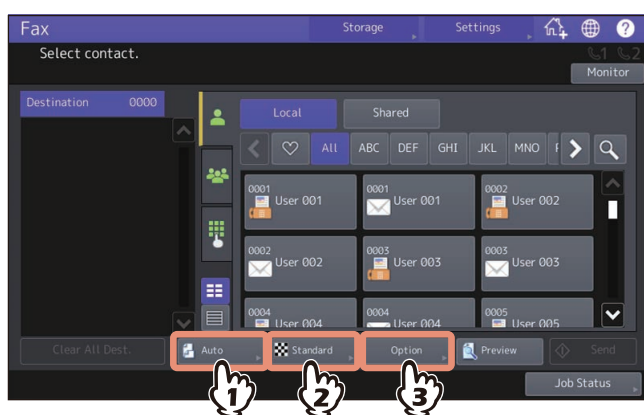

Press each button to display the transmission condition setting screen. For details, see the reference below:

📖 P.21 “Setting the transmission conditions”

4 Specify the recipient.

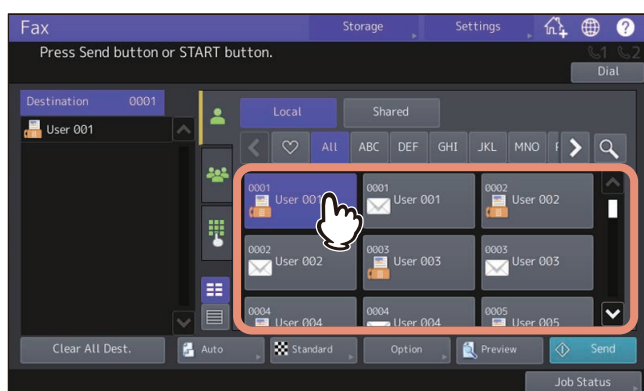

There are multiple methods to specify the recipients. For details, see the reference below:

📖 P.27 “Specifying the recipient”

To display the preview screen, press [Preview].

📖 P.32 “Displaying the preview before sending a fax”

5 Press [Send].



The fax is sent or reserved.

Tip

- Alternatively, you can press the [START] button on the control panel to send a fax.
- In the memory transmission mode, the original is scanned into memory. Once a connection has been made, this equipment automatically starts sending the scanned document. In the direct transmission mode, the fax number is dialed immediately, and the scanned document will be sent. (Transmission conditions can be set in the transmission condition setting screen.)
- If memory becomes full during scanning in the memory transmission mode, that original will not be stored in memory. When that happens, reduce the number of originals you are sending, or try sending them in the direct transmission mode.
- You can check the status of the current sending. You can also cancel the transmission (deletes the job).
 - 📖 P.42 “Checking Communication Status”
 - 📖 P.45 “Canceling the Transmission”

Redial function

In the memory transmission mode, if the fax cannot be sent due to a busy-line, the fax number is redialed automatically to send the fax. By default, this equipment redials 3 times at 1-minute intervals.

Sending the next original

If an original is placed on the original glass and its scanning is completed, the confirmation screen for the next original is displayed. If you want to continue scanning of the next original, place it on the original glass, and then press the [START] button on the control panel. Once all the originals are scanned, press [Job Finish]. If you place an original on the ADF and press [Continue] during scanning, the confirmation screen for the next original can be displayed after the scanning is completed.

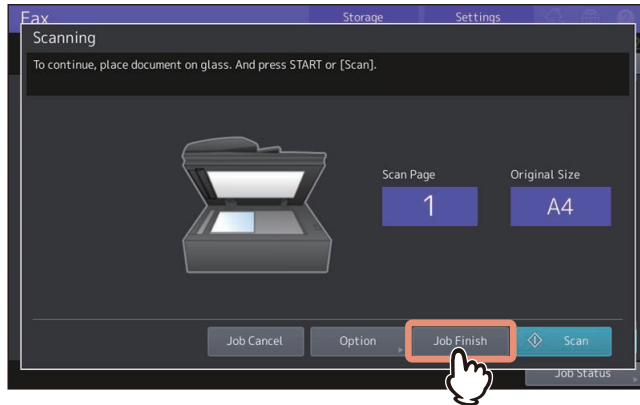

- If you leave the screen unattended for a period of the auto clearance setting time (45 sec. by default), a copy of the scanned originals is sent.
- To cancel the transmission in the memory transmission mode, press [Job Cancel].
 P.45 “Canceling memory transmission job”
- To change the transmission conditions for each page, press [Option].
 P.26 “Changing the settings for each page”

Setting the transmission conditions

You can set the fax transmission conditions.

Tip

- The transmission conditions are only applied to the current transmission. They return to the default settings after the transmission.
- To change the default values of each item, see the reference below:
User Functions - SETTING ITEMS (User) - Fax

❑ Setting the original size

You can set the original size.

1 Press in the Fax menu.

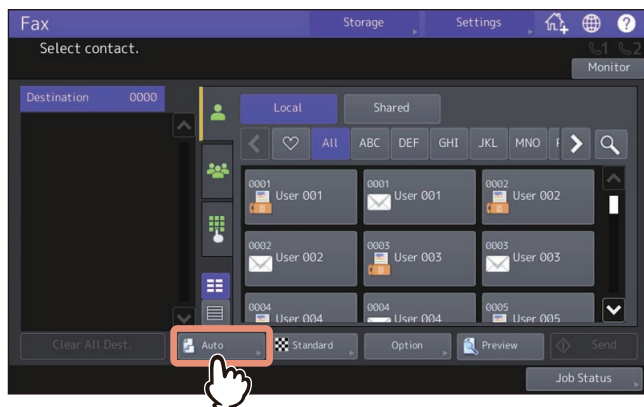

2 Select the original size and press [OK].

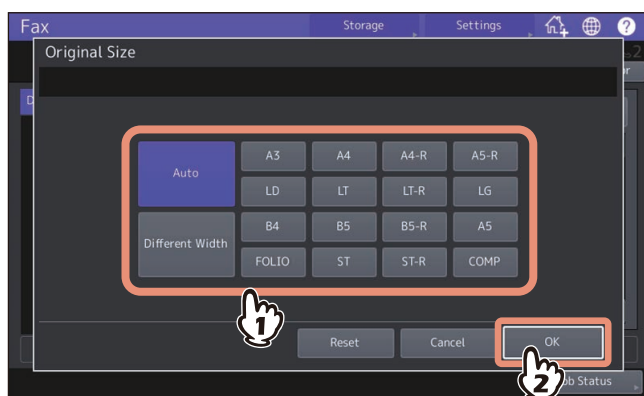

• Original Size

Set the scan size of the original.

- **Auto:** The size of the original is automatically determined before the original is scanned.
- **Different Width:** Select this function to load the originals with different width into the ADF.
- **Specified size:** The original is scanned at the preset size regardless of its actual size.

Tip

- Setup items differ depending on the model.
- If the recipient's fax machine is not capable of receiving originals of B5/B5-R size, this equipment may reduce that size before sending it. To avoid this, when the original to be set is B5 and B5-R size, specify A4 and A4-R size respectively.

❑ Setting the resolution

You can set the resolution when scanning an original.

1 Press  in the Fax menu.

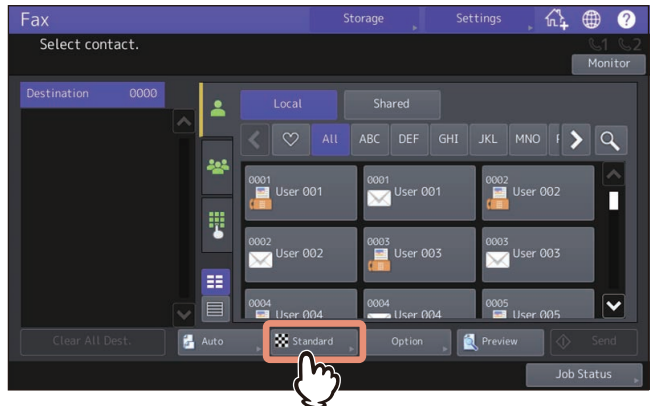

2 Select the resolution and press [OK].

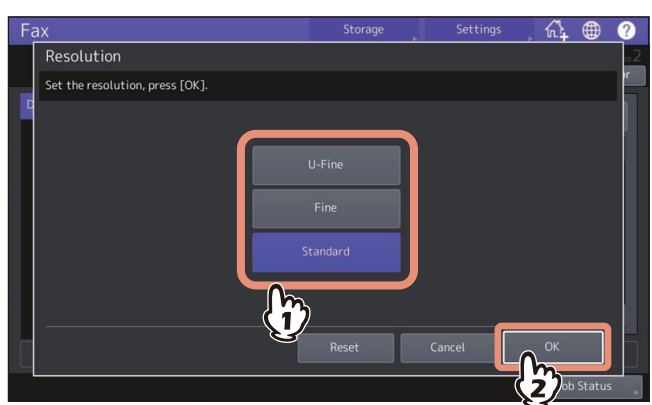

• Resolution

Set the resolution based on the fineness of the original.

- **U-Fine:** This is suitable for an original with ultra-fine illustrations.
- **Fine:** This is suitable for an original with small size text and fine illustrations.
- **Standard:** This is suitable for an original with regular size text.

Tip

- If the recipient's fax machine is not capable of receiving originals at the same resolution, the resolution is automatically converted before being sent to the recipient. The higher the resolution is, the longer it takes to send an original.
- Standard cannot be set in Resolution while the OCR function is enabled.

❑ Setting other transmission conditions

1 Press [Option] in the Fax menu.

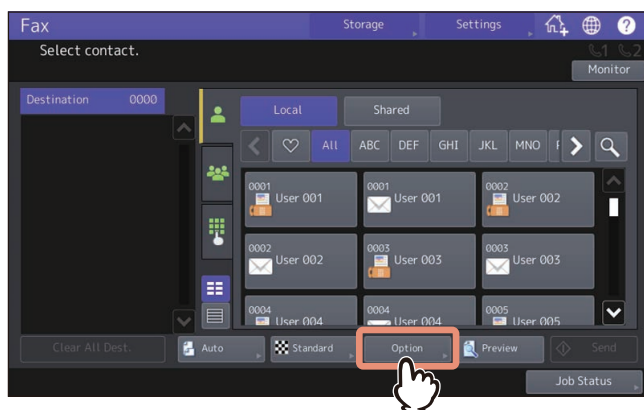

2 Press the desired item and change the setting on the screen displayed.

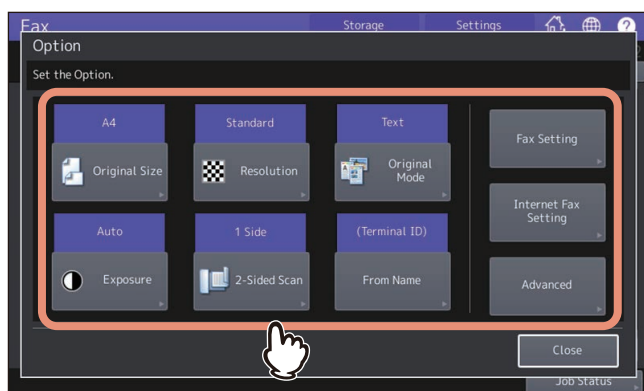

- **Original Size**
This is the same value as the one which can be set on the Fax menu. For details, see the reference below:
 P.22 “Setting the original size”
- **Resolution**
This is the same value as the one which can be set on the Fax menu. For details, see the reference below:
 P.24 “Setting other transmission conditions”
- **Original Mode**
Set the scanning mode based on the type of the original.
 - **Text/Photo:** This is suitable for an original with a mixture of text and photos.
 - **Text:** This is suitable for an original with text and line drawings.
 - **Photo:** This is suitable for an original with photos.
- **Exposure**
Set the density at which the original is to be scanned.
 - **Auto:** This equipment automatically detects the contrast of the original, and scans it with the optimum density.
 - **Manual:** Press or to set the desired contrast.
- **2-Sided Scan**
Select the type (1-sided or 2-sided) of the original to be scanned
 - **1 Side:** Press this button to scan a 1-sided original.
 - **Book:** Press this button to scan a 2-sided right-to-left (book-type) original.
 - **Tablet:** Press this button to scan a 2-sided top-to-bottom (tablet-type) original.

- **From Name**
Set the sender name to be added to the transmission record. When you do not set this, the terminal ID is displayed.
You can register the sender name on the Admin menu. For details, see the reference below:
User Functions - SETTING ITEMS (Admin) - Fax - Registering the terminal ID
- **Fax Setting**
If you want to change each item for the Fax Setting, see the reference below:
📖 P.25 “Changing the Fax Settings”
- **Internet Fax Setting**
If you want to change each item for the Internet Fax Setting, see the reference below:
📖 P.26 “Changing the Internet Fax Settings”
- **Advanced**
If you want to change the advanced conditions for each item, see the reference below:
📖 P.49 “USING THE FAX UNIT (USEFUL FUNCTIONS)”

Tip

In the [Text/Photo] or [Photo], transmission time may be longer than that in the [Text].

Changing the Fax Settings

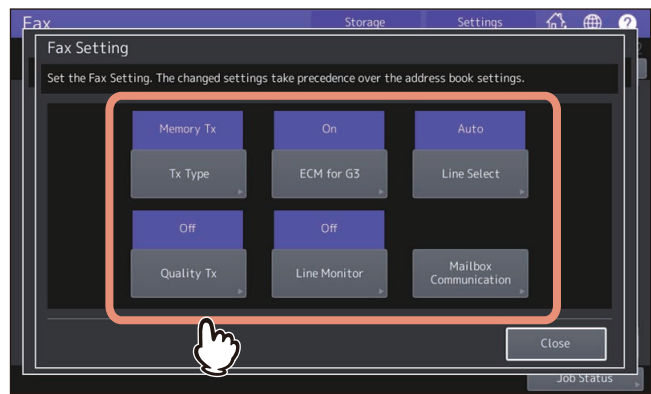

To cancel the operation and return to the previous screen, press [Reset].

- **Tx Type**
Set the fax transmission mode.
 - **Memory Tx:** Send the original after the scanned data are saved in the memory. Up to 100 transmissions of up to 1000 pages per 1 transmission can be reserved.
 - **Direct Tx:** Send the original directly as it is being scanned. Once a page has been scanned and sent, the next page is scanned and sent. Therefore, it takes longer to scan and send all pages. However, you can confirm on the fly that each page is sent to the recipient.
- **ECM for G3**
Switch the ECM (Error Correction Mode) communication On or Off for G3 fax. ECM is an internationally standardized communication mode that automatically corrects errors that occur during fax transmissions. With this setting option On, even when the transmitted data have been affected by noise during communication, this mode allows good communication without image distortion by automatically resending the parts that have been affected.
- **Quality Tx**
Switch Quality Tx On or Off. When this mode is set to On, originals are sent at a slower speed than usual and the chances of errors occurring decrease.
- **Line Select**
Specify the line to be used for sending a fax when multiple fax units are installed.
 - **Auto:** The line is switched automatically.
 - **Line 1:** The 1st line is used.
 - **Line 2:** The 2nd line is used.

• Mailbox Communication

For the communication compatible with ITU-T (International Telecommunications Union-Telecommunications) standards, specify a subaddress or password to be sent to the recipient's fax machine. (Up to 20 digits can be entered.)

- **SUB** (Subaddress): Information to send data of the original to the fax machine.
- **SEP** (Selective Polling): Information to retrieve data of the original from the fax machine.
- **SID** (Sender Identification): Password for SUB.
- **PWD** (Password): Password for SEP.

• Line Monitor

Switch the line monitoring function to [On] or [Off].

Note

- Both the sender and the receiver must have the ECM function to make ECM communication available.
- When affected by noise during communication, communication time is slightly longer than usual. Even when the ECM communication is used, an error may occur depending on the line status.
- The ECM communication is not available for voice communication.
- The setting condition in the address book takes the priority. Therefore, when the recipient's Quality Tx is set to On in the address book, a fax transmission is performed at On even though the Quality Tx remains Off in the Option screen.
- Line Select cannot be selected on some models.

Tip

To use the Mailbox Communication function, the recipient's fax machine must be capable of setting an ITU-T compatible subaddress or password.

Changing the Internet Fax Settings

This is not applicable to standard fax sending.

📖 P.114 "Sending Internet faxes"

- **Subject:** The subject of the Internet Fax.
- **Body:** The body of the Internet Fax.

❑ Changing the settings for each page

You can change the scanning conditions (Resolution, Mode, Exposure, and Original) for each page.

- 1 Specify the recipients and press [Send] to start scanning a document. When the scanning of the original is completed, the confirmation screen for the next original is displayed. Press [Option].**

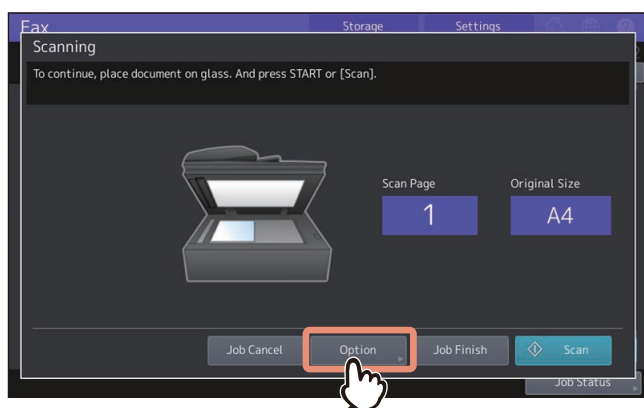

The screen above is displayed when the original placed on the original glass. If you place an original on the ADF and press [Continue] during scanning, the confirmation screen for the next original is displayed after the scanning is completed. If you press [Stop] displayed on the screen during scanning, it will be halted and the confirmation screen for the next original can be displayed.

- 2 The setting screen for the scanning conditions is displayed. Change the settings, and then press [OK].**

📖 P.24 "Setting other transmission conditions"

■ Specifying the recipient

There are various ways to specify the recipient, such as direct entry with the control panel and address book entry.

Tip

- To use the address book, you need to register recipients' fax numbers to the book in advance. For details of the operation, see the references below:

TopAccess - [Registration] - [Registration] Overview - [Address Book] Item list

User Functions - SETTING ITEMS (User) - Address - Managing contacts in address book - Creating new contacts

- **To send to multiple addresses**

In the memory transmission mode, you can send the same document to multiple recipients (up to 400 recipients) at once. When [Multi] is pressed after the fax number has been entered, it will be added to the recipient list displayed on the left-hand side of the screen. Repeat this operation until you specify all recipients. You can also specify up to a total of 400 recipients' fax numbers by combining with other entry methods.

□ Entering directly with digital keys

You can specify the recipient by entering its fax number on the touch panel.

1 Press .

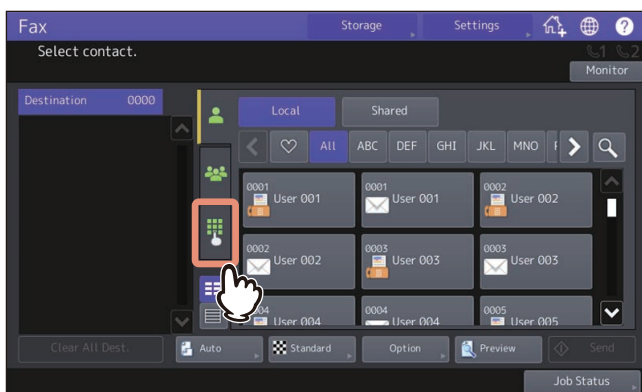

2 Key in the recipient's fax number and press [Send].







Press  to key in the recipient's E-mail address (internet fax) directly.

❑ Specifying the recipient in the address book

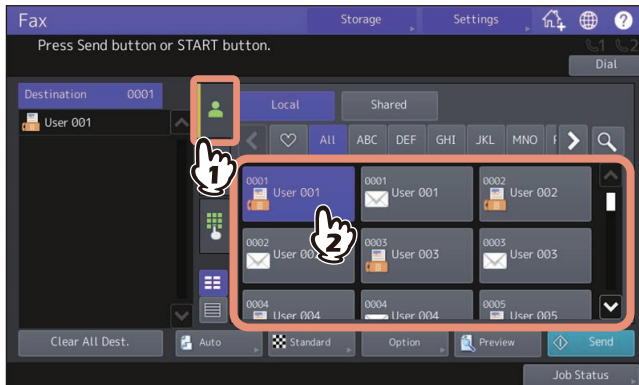
In the address book, you can specify the recipient.

1 Press the desired recipient on the tab.



- To cancel the selected recipient, press it again.
- To confirm the selected recipient or delete an unnecessary recipient, press it in the recipient list displayed on the left-hand side of the screen.
 P.31 “Confirming/Deleting the recipients”
- To refine your search only for items including specified characters, press .
 P.28 “Searching from the address book or LDAP server”

Tip

When you set your favorite or index items in the address book in the registration, the corresponding recipients appear on the  (favorite) tab or index tab.

❑ Searching from the address book or LDAP server



You can search for the recipient's fax number from the address book or LDAP server.

Tip

To search for the recipient's fax number from the LDAP (Lightweight Directory Access Protocol) server, the name of the LDAP server to be connected is required to be registered to the MFP in advance. For details on the LDAP server, ask your network administrator.

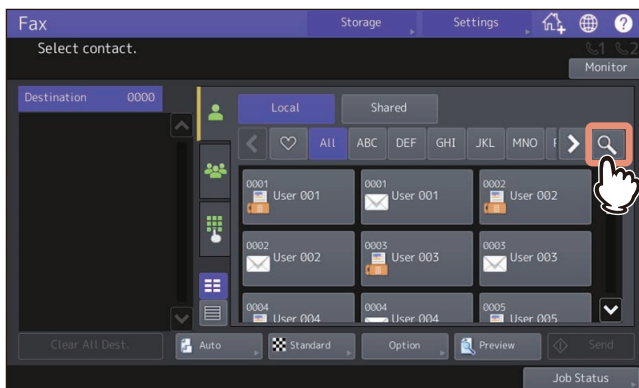
1 Select the or tab and press .



- To display the recipient search menu, press  while the address list is displayed.
- To display the group search menu, press  while the group list is displayed.

2 Enter the keyword in the category which you want to use for searching. Press [Search].

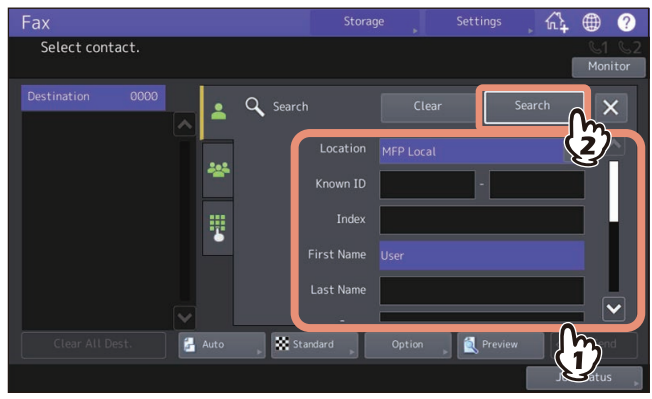

You can search for the desired recipient's fax number by specifying multiple keywords. You can search for contacts even if you enter the partial strings. If you enter multiple search conditions, only the contacts which meet all the entered conditions are displayed as the search results.

- **Location**
Select a location where the address book to be searched is stored. By selecting "MFP Local", you can search the address book of this equipment and a shared address book.
- **Known ID**
Use it when you want to search with the Known IDs registered in the address book. You can specify the range of the ID numbers.
- **Index**
Use this when you want to search with the index registered in the address book.
- **First Name**
Use this when you want to search with the first name registered in the address book.
- **Last Name**
Use this when you want to search with the last name registered in the address book.
- **Corp.**
Use this when you want to search with the corporate name registered in the address book.
- **Dept.**
Use this when you want to search with the department registered in the address book.
- **Keyword**
Use this when you want to search with the characters written in the Keyword which are registered in the address book.
- **Fax No.**
Use this when you want to search with the fax number registered in the address book.
- **E-mail**
Use this when you want to search with the E-mail address registered in the address book.
- **Send Type**
Use this when you want to search either fax number or E-mail address.

Selecting the LDAP server

To search for the recipient's fax number in the LDAP server, select the one you want to search in the pull-down menu of Location on the Search screen.

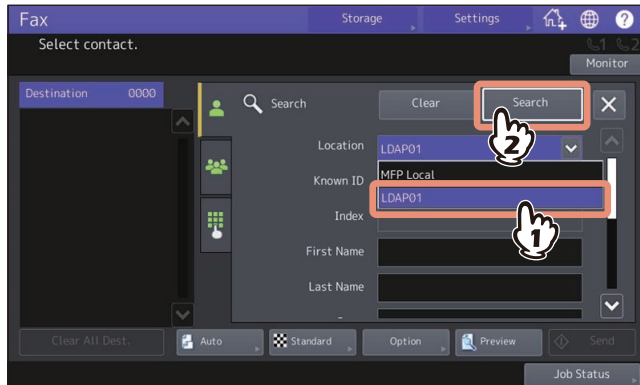

Tip

A searched destination in an LDAP server can be registered in the address book by selecting it on the search result screen and pressing [Entry].

3 The search result is displayed. Select the desired recipient and press [Send].

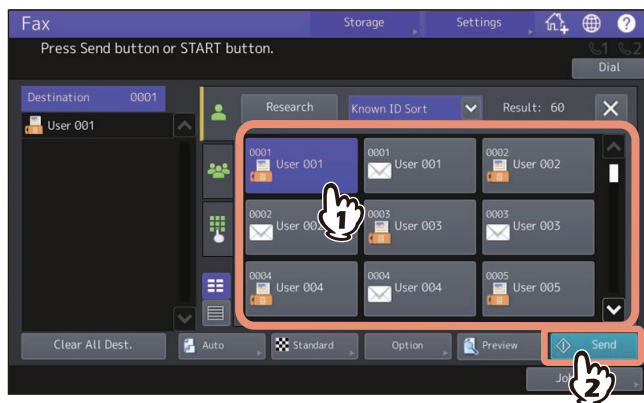



- To cancel the selected recipient, press it again.
- If you want to change the results of the search, press [Research]. You will be returned to the screen in step 2. Specify the search string again.
- You can switch the screen by selecting [Known ID Sort] or [Index Sort].

❑ Specifying the group in the address book

In the address book, you can specify the group to which you want to send a fax.

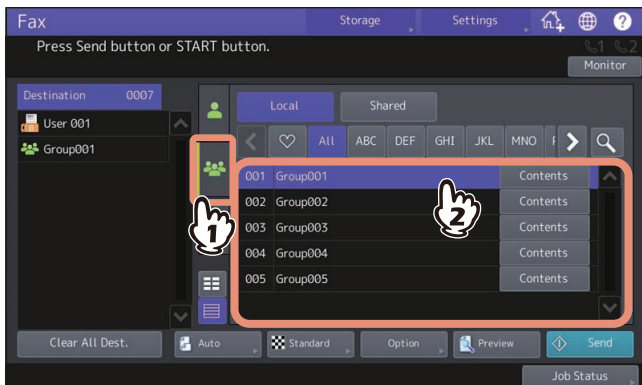
- 1 Press the  tab to select the group to send a fax to.



- To cancel the selected group, press it again.
- To confirm the fax number or the E-mail addresses registered in the group, press [Contents].
- To delete an unnecessary recipient, press it in the recipient list displayed on the left-hand side of the screen.
[P.31 “Confirming/Deleting the recipients”](#)
- To refine your search only for items including specified characters, press .
[P.28 “Searching from the address book or LDAP server”](#)

❑ Confirming/Deleting the recipients

You can confirm the recipients which you specified or delete unnecessary recipients.

- 1 Select the recipient to confirm from the recipient list displayed on the left-hand side of the screen.

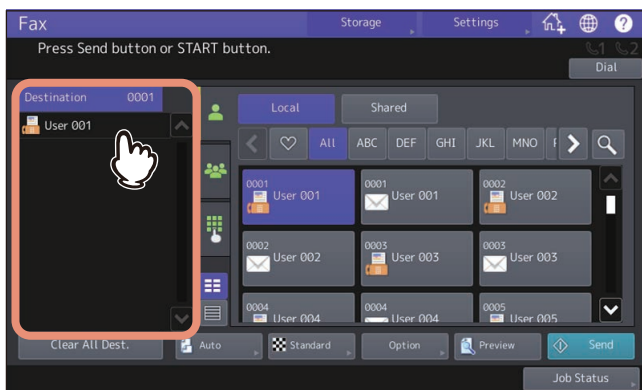

Details of the selected recipient appear.

Tip

- Details of the members included in the group cannot be confirmed with this operation. Press [Contents] when the group is selected.
[P.31 “Specifying the group in the address book”](#)
- Press [Clear All Dest.] to delete all recipients displayed in the list.

- 2 Confirm the recipients on the screen displayed. Press [Clear] to delete the recipients or groups from the recipient list.

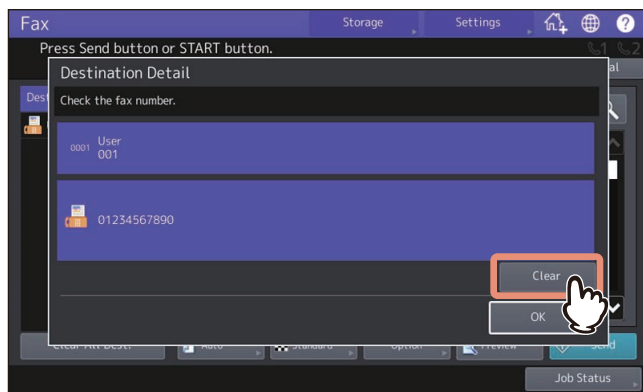

- 3 When [Clear] is pressed, a confirmation message will appear. Press [OK].
The recipients selected are deleted from the recipient list.

■ Displaying the preview before sending a fax

Before sending a fax, you can check the image on the touch panel with this preview function.

Tip

When dialing on-hook transmission or off-hook transmission, you cannot use the preview function.

- 1 Press [Preview] on the fax menu.

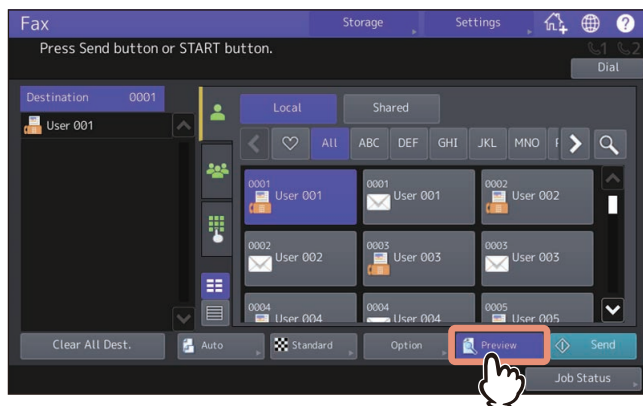

To use the preview function, press [Preview] before pressing [Send].

- 2 Specify the recipient and set the transmission conditions. Press [Send].

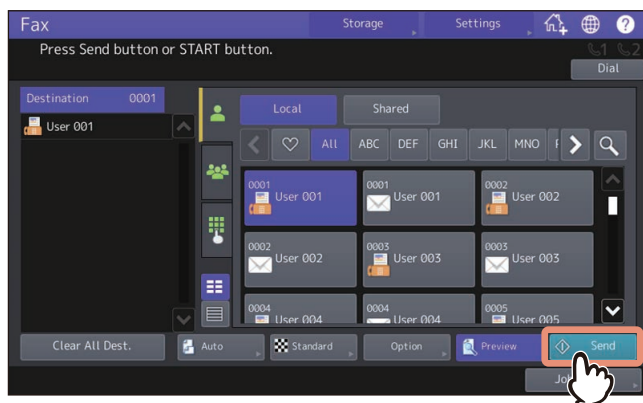

For details about how to specify the recipient and set the transmission conditions, see the references below:

- 📖 P.21 “Setting the transmission conditions”
- 📖 P.27 “Specifying the recipient”

3 Carefully check the displayed preview of your scans and the number of pages. To save or E-mail your scans, press [OK].



- The number of pages of your scanned original is displayed on the upper right of the screen.
- If you want to scan another original continuously, place it on the original glass or in the ADF, and then press the [START] button.
- When the page to confirm is selected, it is enlarged and the preview operation, such as the enlargement/reduction of the display or the replacement/insertion of a page, becomes possible.
- To replace the page being previewed with another page, press [Replace Page], place a new original and press [OK].
- To insert another scan before the page being previewed, press [Insert Page].
- To delete the page being previewed, press [Edit] and then **x** on the page to be deleted. However, **x** is not displayed if only one page is being previewed.
- To change the setting, press [Option].
 📖 P.21 “Setting the transmission conditions”



■ On-hook transmission/Off-hook transmission

□ On-hook transmission

You can dial and perform direct fax transmission without picking up the handset of the external telephone. On-hook Transmission is available when  on the upper right of the screen is OFF.

Note

On-hook transmission using a 2nd line is not available.

- 1 Place the original(s).**
 P.14 “Placing an original”
- 2 Press [Fax] on the Home screen.**
- 3 Set the transmission conditions.**
 P.21 “Setting the transmission conditions”
- 4 Press [Monitor].**

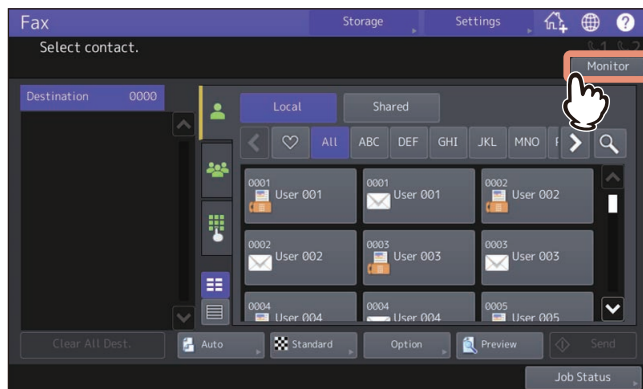

- Make sure that you hear the dial tone from the built-in speaker.
- To cancel the operation, press [Monitor] again.

Note

When you specify the recipients by searching them, perform the next procedure in advance. In this case, specify the recipients, and then press [Dial].

- 5 Specify the recipients.**
 P.27 “Specifying the recipient”

Note

- For direct entry, press  to dial a number. If you make a mistake when dialing the fax number, press [Monitor] to cut the line, and then press it again to redial.
- If you specified the recipient with the search, press [Dial].

- 6 When you hear the answer tone (short high-pitched tone) through the built-in speaker indicating the connection has been made with the recipient's machine, press [Send].**



 P.19 “Sending a Fax”

Note

When you hear the other party's voice answering the call before pressing [Send], pick up the handset of the external telephone. Then ask him/her to perform operation of the fax reception.

☐ Off-hook transmission

You can pick up the handset of the external telephone to dial and perform direct fax transmission. Off-hook Transmission is available when  on the upper right of the screen is OFF.

- 1 Place the original(s).**
 P.14 “Placing an original”
- 2 Press [Fax] on the Home screen.**
- 3 Press [Option] and set the transmission conditions.**
 P.21 “Setting the transmission conditions”
- 4 Pick up the handset of the external telephone.**

Note

When you specify the recipients by searching them, perform the next procedure in advance. Press [Dial] after specifying the recipients.

- 5 Use the external telephone to dial the fax number.**
 P.27 “Specifying the recipient”

Note

- When you use the external telephone to dial, the machine dials each number you enter. If you make a mistake when dialing the fax number, replace the handset to cut the line, and then pick up the handset again to redial.
- When you specify the recipients by searching them, press [Dial].

- 6 When you hear the answer tone (short high-pitched tone) through the built-in speaker indicating the connection has been made with the recipient’s machine, press [Send].**
 P.19 “Sending a Fax”

Note

When you hear the other party’s voice answering the call before pressing [Send], ask him/her to perform operation of the fax reception.

- 7 Replace the handset of the external telephone.**

■ Originals and paper

□ Acceptable size of paper

A3, B4, A4, B5, A5, FOLIO, LD, LG, LT, ST and COMP sized paper are available.

The printing range of each size of paper is as follows: If an original contains any information outside of the printable area, it is not printed on the paper.

- **e-STUDIO6525AC Series:** Leading edge 4.2 mm (0.17"), Trailing edge 3 mm (0.12"), Both edges 2 mm (0.08")
- **e-STUDIO6528A Series:** Leading edge 3 mm (0.12"), Trailing edge 2 mm (0.08"), Both edges 2 mm (0.08")
- **e-STUDIO7527AC Series:** Leading edge 4.2 mm (0.17"), Trailing edge 2 mm (0.08"), Both edges 2 mm (0.08")
- **e-STUDIO9029A Series:** Leading edge 3 mm (0.12"), Trailing edge 2 mm (0.08"), Both edges 2 mm (0.08")

Note

When B5 size paper is used, set B4 size paper in another drawer.

Tip

- Set the paper in the drawers or the Large Capacity Feeder. The bypass tray is not available.
- Regardless of whether or not the Finisher is installed, paper exits on the receiving tray.
- Drawers can be set for fax use only. For details, see the reference below:
Preparation of Paper (e-STUDIO6525AC Series/e-STUDIO6528A Series) - LOADING PAPER - Doing Paper Settings - Setting paper type
Preparation of Paper (e-STUDIO7527AC Series/e-STUDIO9029A Series) - LOADING PAPER - Doing Paper Settings - Setting paper type

□ Default setting for Rx printing

To print the received fax, the paper with the same width as the original is used. Depending on the length of the original, "Rx reduction printing" or "Discard printing" (both of them are set to ON by default) are applied.

For details about the setting Rx printing, see the reference below:

User Functions - SETTING ITEMS (Admin) - Fax - Setting Rx printing

When an original is shorter or the same as the paper printing area

It is printed in the original size.

When an original is longer than the paper printing area

It is printed according to the following priority:































- When an original is up to 10 mm (0.4") longer than the printing area: the part of the originals that exceeds the paper printing area is discarded.
- When an original exceeds the printing area by more than 10 mm (0.4"): the original image is reduced to 75 % (reduction printing). If the image still cannot be fitted into the printing area, paper larger than the original is selected. In case there is no larger paper available, the original is printed with the image divided.

Paper priority when there is no same size paper

When both “Rx reduction printing” and “Discard printing” are set to ON, paper is selected according to the following priority:

1. Paper of the same size and the same orientation as the original
2. Paper of the same size but with a different orientation to the original
3. Paper of the same orientation but larger than the original































North American format

Size of Original being Received \ Priority	Ledger	Legal	Letter	Letter	Statement	COMP
1	 Ledger	 Legal	 Letter	 Letter	 Statement	 COMP
2	 Ledger	 Legal	 Letter	 Letter	 Statement	 COMP
3		 COMP	 Letter	 Letter	 Letter	 Ledger
4			 Ledger	 Legal	 Letter	 Letter
5			 Legal	 COMP	 Legal	 Letter
6			 COMP	 Ledger	 COMP	 Legal
6					 Ledger	

Note

- The selectable paper sizes differ depending on the models.
- When the corresponding paper size is not available, in most cases, the scanned original is printed on paper of a larger size. However, the sender’s fax machine may reduce the scanned original to fit the paper size available in the recipient’s fax machine (this equipment). (Ex. LD to LT)
- The paper priority varies according to the “Rx reduction printing” and “Discard printing” settings. For details, contact your service technician.

A/B format

Size of Original being Received \ Priority	A3	B4	A4	A4-R	B5	A5	FOLIO
1	 A3	 B4	 A4	 A4-R	 B5	 A5-R	 FOLIO
2		 A3	 A4-R	 A4	 B5-R	 A4-R	 B4
3			 A3	 FOLIO	 B4	 A4	 A3
4			 FOLIO	 B4	 A4	 FOLIO	
5			 B4	 A3	 A4-R	 B5	
6					 A3	 B5-R	
7					 FOLIO	 B4	
8						 A3	

Note

- The selectable paper sizes differ depending on the models.
- When the corresponding paper size is not available, in most cases, the scanned original is printed on paper of a larger size. However, the sender's fax machine may reduce the scanned original to fit the paper size available in the recipient's fax machine (this equipment). (Ex. A3 to A4)
- The paper priority varies according to the "Rx reduction printing" and "Discard printing" settings. For details, contact your service technician.

■ Reception mode

This section describes how to receive a fax. Refer to the appropriate section for your current reception mode. The reception mode can be set on the Admin menu. For details of the current setting, ask your administrator. Besides the receiving methods described in this section, there are various useful ways to receive a fax. These procedures are described in the references below:

- 📖 P.51 “Communicating to a Request from a Recipient (Polling Communication)”
- 📖 P.53 “Using the Mailbox Function”

Tip

Fax reception settings can be changed from TopAccess.
For details, see the reference below:

TopAccess - [Administration] - [Setup] Item List - Fax settings - Setting up Fax Setting

□ Auto reception

Faxes are automatically received during an incoming call. Users do not have to do anything when receiving a fax.

Tip

When multiple fax units are installed, the reception mode of the 2nd line is limited to “Auto reception”.

□ Manual reception

Faxes are manually received by using an external telephone when you have an incoming call.

- 1 Pick up the handset of the external telephone when you have an incoming call.**
If the incoming call is a telephone call, you can start talking.
- 2 When you hear a tone (fax signal) through the handset of the external telephone, press [Fax] on the Home screen.**
- 3 Press the [Manual Rx].**

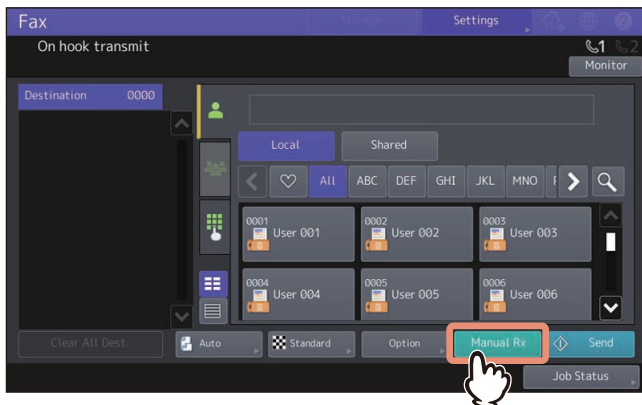

- 4 When a message indicating that you can receive a fax appears, press [Receive] on the touch panel or the [START] button on the control panel. Replace the handset of the external telephone.**

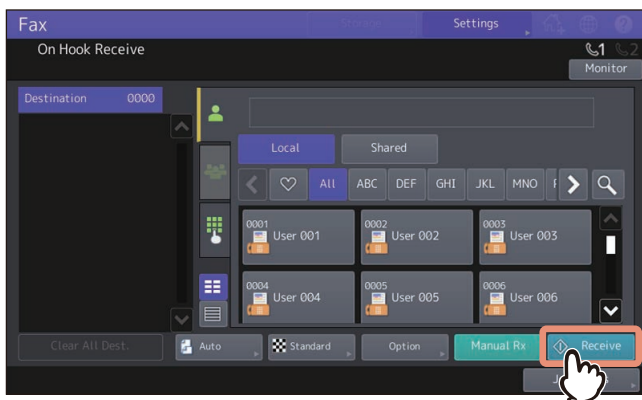

❑ Memory reception

The received fax data are stored in the memory, the faxes are automatically printed as soon as the equipment becomes ready. As the memory reception function is always enabled, you do not need to make any setting.

❑ Displaying the preview of a received fax

You can confirm the contents on the touch panel before carrying out the printing of a fax received by means of the [Hold (Fax)], [Secure Rx (Line 1)] and [Secure Rx (Line 2)] option.

1 Press [Print] on the Home screen.

The print screen is displayed. If you leave the screen unattended for the auto clear setting time (45 sec. by default), the screen returns to the default one automatically.

2 Select [Hold (Fax)], [Secure Rx (Line 1)] or [Secure Rx (Line 2)] for Job Type.

If the equipment is running in the High Security mode, [Secure Rx (Line 1)] and [Secure Rx (Line 2)] are not displayed.

Tip

- When  is pressed, received fax jobs are displayed in the list.
- To delete a received fax from the list, select the received file subject to delete and press [Delete].

When  is pressed, received fax jobs are displayed in thumbnail images.

- To delete a received fax from the thumbnail, select the thumbnail image subject to delete and press [Delete].
- The entry of the password is required at the first operation of any of [Delete], [Print], [Display Image] or the thumbnail images.

3 Press [Preview].

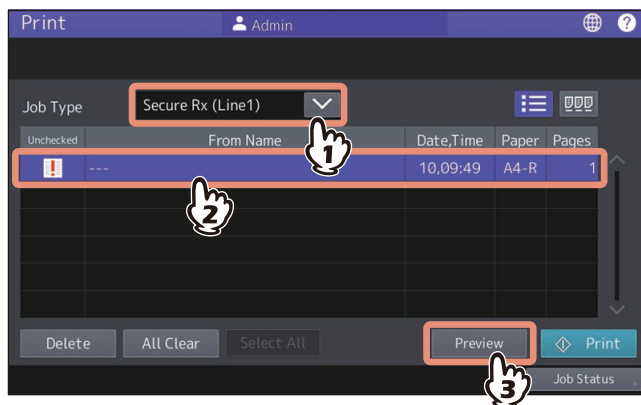

4 Enter the password for printing secure receive fax jobs.

Tip

After the password is entered and then [OK] is pressed,  mark in the Unchecked field disappears. When the screen is shifted to another one and then is returned to this one, the entry of the password is required when preview or printing is carried out.

5 When the preview is displayed, confirm the fax image and the number of pages. To print a received fax as it is, press [Print]. Printing starts.

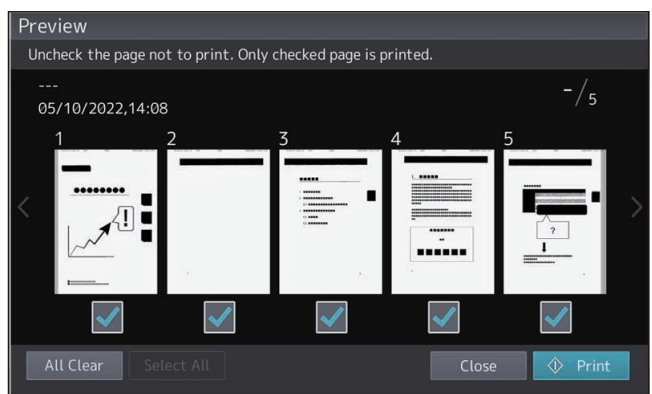

- When a page to confirm is selected, it is enlarged and the preview operation, such as the enlargement/reduction of the display or the rotation of the page, becomes possible.
- Press on the page to be rotated. The page is rotated by 90 degrees by each one time is pressed.
- Uncheck of the pages which will not be printed.

Note

When printing is performed by specifying the page, the received fax is not deleted even if all pages are selected. Print or delete the received fax on the screen in step 3.

Checking Communication Status

■ Checking reserved transmissions

You can check reserved fax transmissions.

1 Press [Job Status].

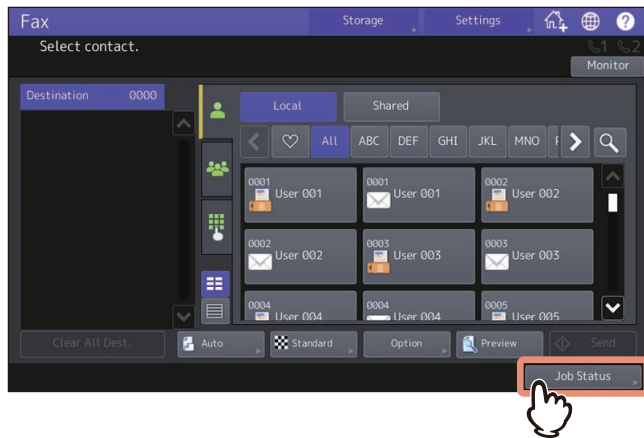

2 Press [Fax].

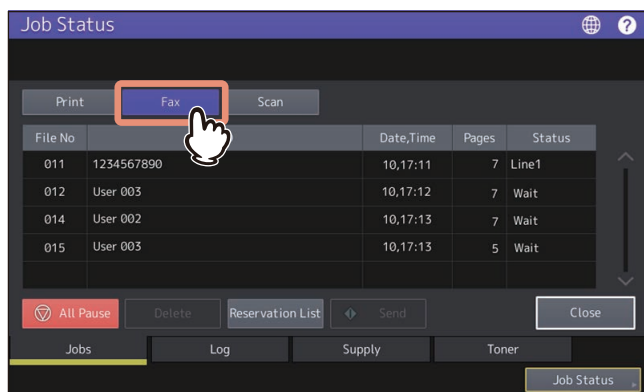

- Reserved transmission jobs are listed up to 100 transmissions in the chronological order from top to bottom.
- To print the list of the reserved transmissions jobs, press [Reservation List].
- In the “Status” column, the status of each job is indicated as follows:
 - Line1: Sending on the 1st line.
 - Line2: Sending on the 2nd line.
 - Network: Reserved for sending via Internet Fax.
 - Delayed: Reserved with the time to send specified.
 - Wait: Communication is in the standby queue.
 - Invalid: Under standby due to an invalid department code (Network Fax). Confirm the department code and delete any unnecessary reserved transmissions in the standby queue. For each operation, see the references below:
 - 📖 P.95 “Setting up the [Send] tab”
 - 📖 P.47 “Canceling reserved transmissions”

Tip

The 2nd line for FAX Unit is not available to some models.

■ Checking communication log

You can check the log of fax transmissions and receptions.

1 Press [Job Status].

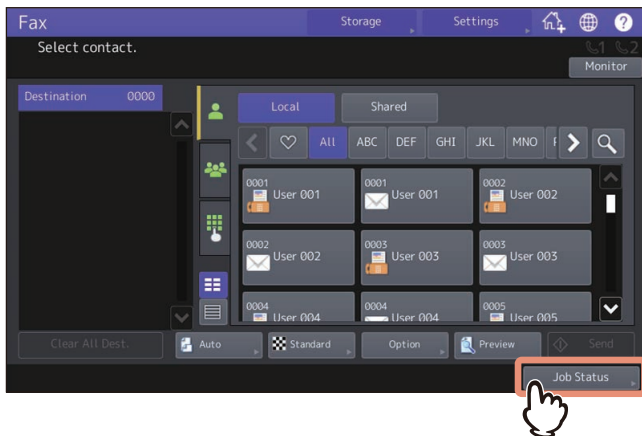

2 Select the [Log] tab, and then press [Send] or [Receive].

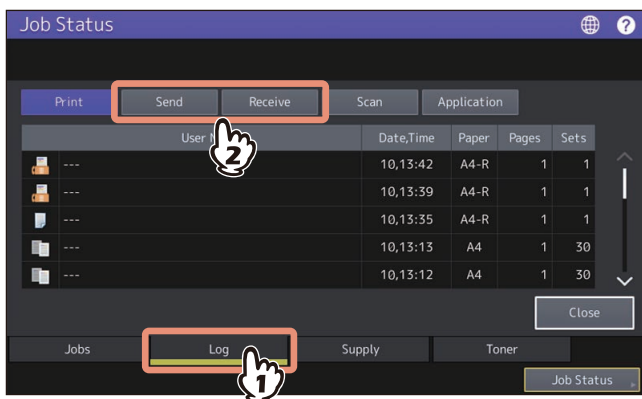

3 The list of the communication status is displayed.

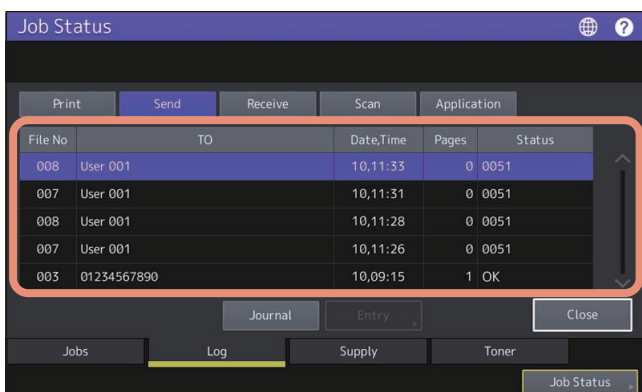

- Transmissions or receptions are listed in the reversed chronological order from top to bottom.
- To print the log of transmissions or receptions, press [Journal].
 P.75 “Journal (transmission journal/reception journal)”
- In the “Status” column, the status is indicated as follows:
 OK: Transmission or reception succeeded.
 4-digit error code: Transmission or reception failed.
 For details about the error codes, see the reference below:
Frequently Asked Questions - QUESTIONS FOR ERROR CODES - Questions for Error Codes - Error codes on transmission and reception

-
- The Send and Receive logs can be downloaded to a USB storage device. For details, see the reference below:
User Functions - SETTING ITEMS (Admin) - General - Exporting logs

Registering recipients' fax numbers to the address book

To register recipient's fax numbers in the address book from the send/receive log screen, select a record in the send or receive log, and then press [Entry]. For details of the registration to the address book, see the reference below:

User Functions - SETTING ITEMS (User) - Address - Managing contacts in address book - Creating new contacts

Note

- Fax and E-mail transmissions whose recipients are specified with direct entry or entry using the LDAP server can be registered to the address book from the Send log.
- Polling and E-mail receptions whose recipients are specified with direct entry or entry using the LDAP server can be registered to the address book from the Receive log.

Canceling the Transmission

■ Canceling memory transmission job

You can cancel the memory transmission during scanning.

□ When using the original glass

This section describes how to cancel the memory transmission when an original is placed on the original glass.

- 1** When scanning is completed, the confirmation screen for the next original is displayed. Press [Job Cancel].

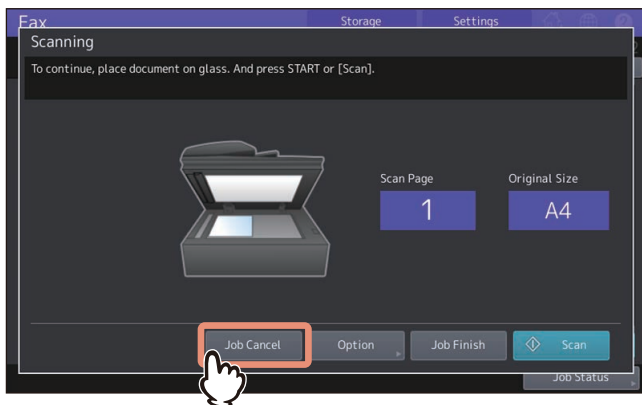

If you leave the screen unattended for a period of the auto clearance setting time (45 sec. by default) after the confirmation screen for the next original is displayed, a copy of the scanned originals is sent.

- 2** The confirmation screen is displayed. Press [Yes].

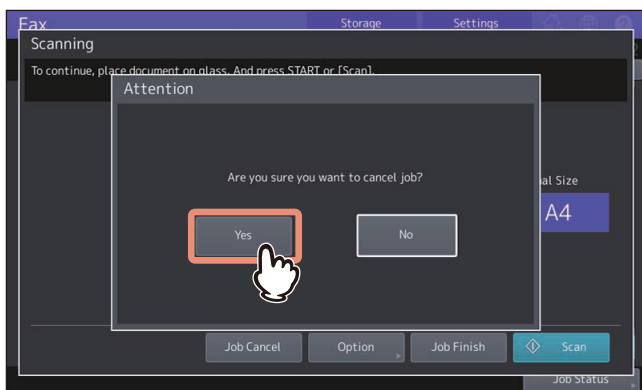

❑ When using the ADF

This section describes how to cancel the memory transmission when originals are placed on the ADF.

1 Press [Stop] displayed on the screen while the originals are being scanned.

Scanning is paused.

2 The confirmation screen for the next original is displayed. Press [Job Cancel].

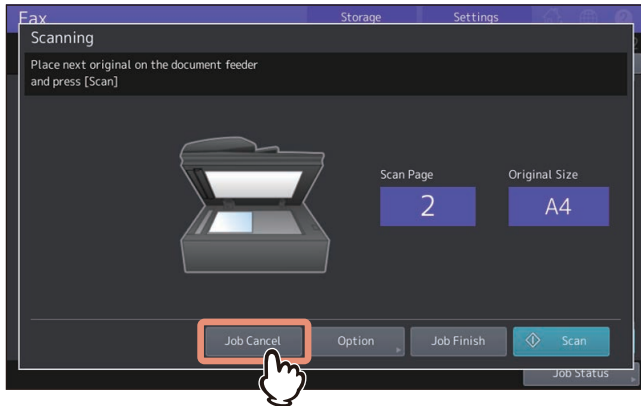

- If you press [Job Finish], the scanned originals are sent.
- If you leave the screen for the next original unattended for the period of the auto clear setting time (45 sec. by default) after it appears, the scanned originals are sent.

3 The confirmation screen is displayed. Press [Yes].

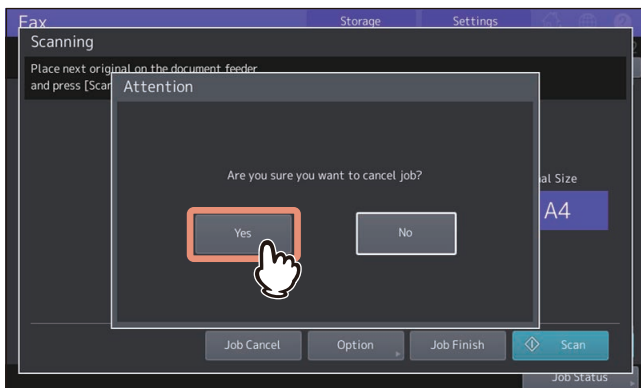

■ Pausing transmission

You can stop a transmission job during scanning.

Note

Even if you cancel transmission in the direct Tx mode, the part of the original that was scanned before transmission is canceled has been sent.

- 1 **Press [Stop] displayed on the screen while the originals are being scanned.**
The scanning and transmission are stopped.

■ Canceling reserved transmissions

You can display the list of the reserved transmissions, and cancel the reserved transmissions that are in the queue or in progress.

- 1 **Press [Job Status], and then press [Fax].**
The list of the reserved transmissions is displayed. This step is the same as that for checking the reserved transmission.
 P.42 “Checking reserved transmissions”
- 2 **Select the reserved transmission you want to delete, and then press [Delete].**
More than one job can be selected.

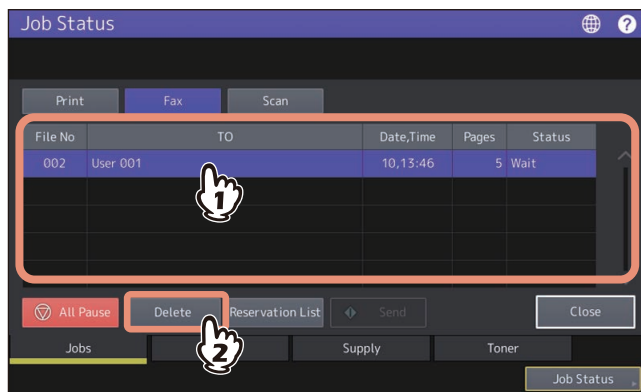

In the “Status” column, you can check the status of the reservation. “Wait” indicates that the data are waiting to be sent. “Line1” or “Line2” indicates that the data are being sent. Delayed transmission reservation and polling transmission/reception can be canceled.

- 3 **The confirmation screen for the deletion is displayed. Press [Delete].**

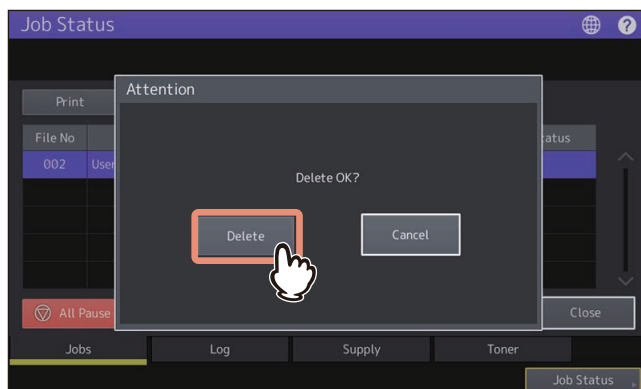

USING THE FAX UNIT (USEFUL FUNCTIONS)

Prioritizing Transmissions (Priority Reserve)	50
Communicating to a Request from a Recipient (Polling Communication)	51
Storing data of originals in the memory (polling transmission).....	51
Requesting to send data of originals (polling reception)	52
Using the Mailbox Function	53
Registering, printing, and deleting originals (mailbox transmission).....	54
Sending and retrieving originals (mailbox transmission).....	57
Creating, modifying, and deleting a mailbox (mailbox transmission)	59
Dialing numbers by Chaining Multiple Sets of Numbers (Chain Dial Communication)	64
Sending Faxes at Specified Dates and Times (Delayed Transmission Reservation)	65
Resending Unsent Data (Recovery Transmission)	66
E-mailing Data Received Via the Mailbox (Onramp Gateway)	67
Sending Data Received by E-mails Via the Mailbox (Offramp Gateway)	68
Saving Transmitted Fax Data to the Shared Folder	69
Specifying the network folder	71
Printing Secure Receive fax jobs	73
Printing Lists and Reports	75
Printing Lists & Reports Manually	75
Printing Lists & Reports Automatically	77

Prioritizing Transmissions (Priority Reserve)

You can send a fax prior to other reserved transmissions (including redial standby).

Tip

Note that each setting will automatically return to its default setting when transmission is completed.

- 1 Place the original(s).**
P.14 “Placing an original”
- 2 Press [Fax] on the Home screen.**
- 3 Set the transmission conditions.**
P.21 “Setting the transmission conditions”
- 4 Press [Option] > [Advanced] > [Priority Reserve].**

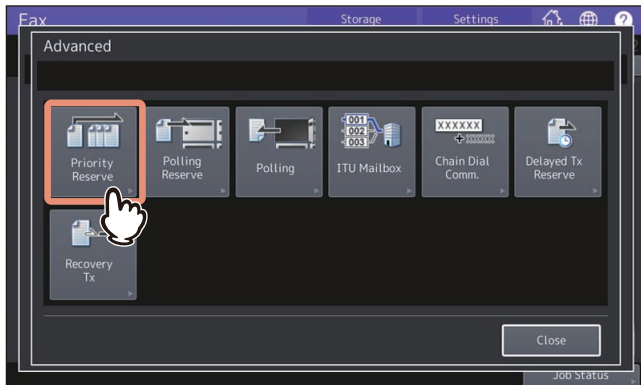

- 5 Press [OK].**
- 6 Specify the recipient's fax number.**
P.27 “Specifying the recipient”

Tip

In the priority transmission mode, you cannot specify multiple recipients' fax numbers.

- 7 Press [Send].**
P.19 “Sending a Fax”

Communicating to a Request from a Recipient (Polling Communication)

The polling communication function allows you to receive pending originals in the sender's fax machine by manually operating the receiving fax machine. In this document, the operation in which this equipment is used as the sender's fax machine is called "polling transmission" while that in which it is used as the recipient's fax machine is called as "polling reception".

■ Storing data of originals in the memory (polling transmission)

Upon request of a recipient's fax machine, this equipment sends an original document stored into the memory to the recipient. By setting a recipient's fax number to an original stored into the memory, you can permit specific recipients to receive the original using the polling transmission.

- 1 Place the original(s).**
📖 P.14 "Placing an original"
- 2 Press [Fax] on the Home screen.**
- 3 Set the transmission conditions.**
📖 P.21 "Setting the transmission conditions"
- 4 Press [Option] > [Advanced] > [Polling Reserve].**

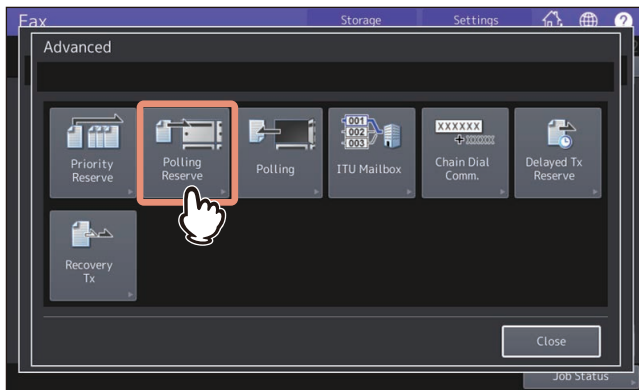

- 5 If you set the fax number (the recipient's telephone number), key in the number (maximum 20 digits), and then press [OK].**

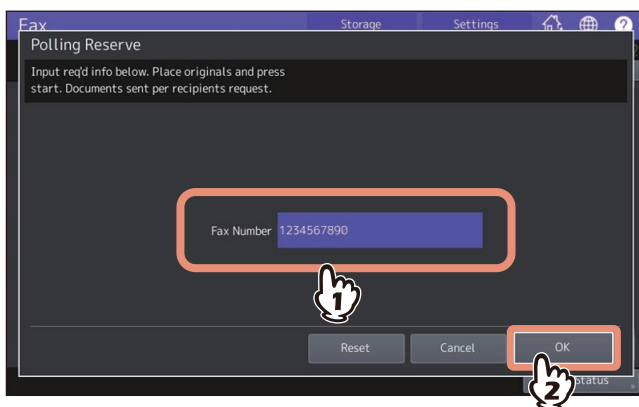

If you don't have to set the fax number, leave it blank and press [OK].

- 6 Press the [START] button on the control panel.**
 - Upon request of the recipient's fax machine, the data of the original stored into memory are sent automatically. Once they are sent, they are deleted from memory.
 - You can delete the data of the original from memory by canceling the polling transmission.
📖 P.42 "Checking reserved transmissions"

■ Requesting to send data of originals (polling reception)

This equipment requests the sender's fax machine to send the data of the originals.

- 1 Press [Fax] on the Home screen.
- 2 Press [Option] > [Advanced] > [Polling].

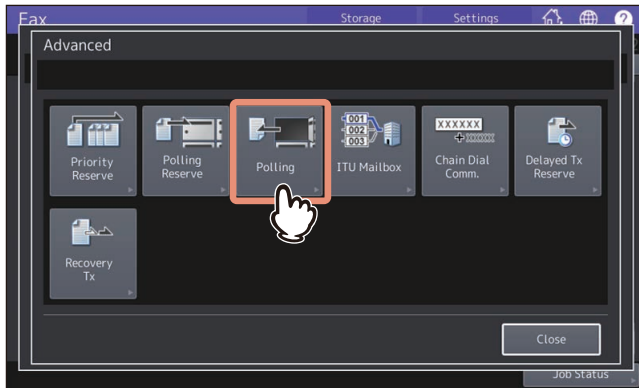

- 3 Press [OK].

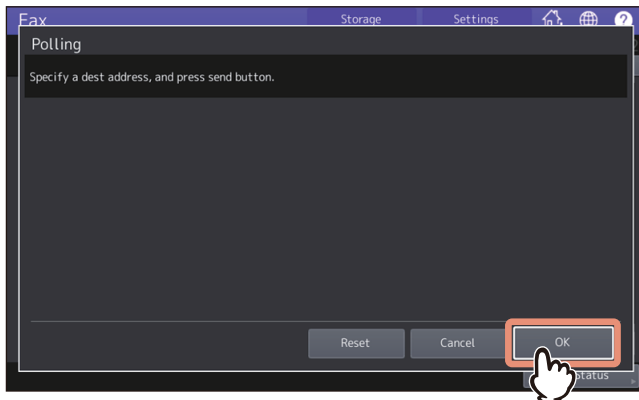

- 4 Specify the sender's fax number.

 P.27 "Specifying the recipient"

Tip

This equipment supports two types of receptions: Individual polling reception in which you specify a recipient's fax number and Multi-polling reception in which you specify multiple recipients' fax numbers.

- 5 Press [Send].

 P.19 "Sending a Fax"

Tip

With the delayed transmission reservation, you can perform the polling reception on a specific date and time. To do that, set the date and time before pressing [Send].

 P.65 "Sending Faxes at Specified Dates and Times (Delayed Transmission Reservation)"

Using the Mailbox Function

This function is used to communicate between fax machines compatible with a mailbox function (ITU-T compatible). The owners of these fax machines can input or retrieve the data of the originals in the mailbox. There are 3 types of mailbox: confidential mailbox, bulletin board mailbox and relay station mailbox. To perform mailbox communication, the mailboxes must be created in advance. An individual password for each box can be set for security protection.

P.59 "Creating, modifying, and deleting a mailbox (mailbox transmission)"

- **Confidential mailbox**

Once data of an original are retrieved from this mailbox, these data will be deleted. This mailbox is suitable for registering an original you want to send to a specific recipient. If a new original is registered in this mailbox in which another original exists, the mailbox will contain both of the originals.

- **Bulletin board mailbox**

No matter how many times an original is retrieved from this mailbox, the original will not be deleted. This mailbox is suitable for registering an original you want to send to multiple recipients. If a new original is registered in this mailbox in which another original exists, the existing original will be replaced with the new original and the new one will be stored in the mailbox.

- **Relay station mailbox**

Using this mailbox, an original sent from a fax machine is relayed to pre-registered multiple recipients. To inform a user of the result of the relay, a report called RELAY TX END TERMINAL REPORT can be sent to a specific recipient. A copy of the original can be printed out (regularly or when an error occurs).

<Example of how to use the relay station mailbox>

If you want to send a copy of an original from an office in Los Angeles to multiple offices in New York, you first send it from the one in Los Angeles to one of the offices in New York where the relay station mailbox is set up, so that it is relayed to the other offices in New York. This will reduce communication costs.

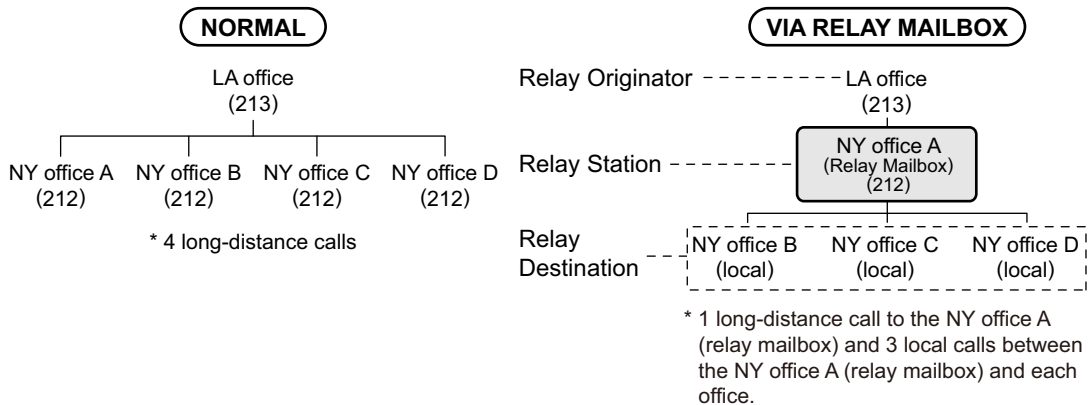

Tip

If you create a forward mailbox whose number is the fax number of the sender, you can use the TSI function. Using this function, this equipment forwards the original sent from the sender whose fax number is set to the mailbox number, based on the pre-set agent (Save as File / Email / Store to e-Filing). This can be set from TopAccess. For details, see the reference below:

TopAccess - [Registration] - [Registration] Overview - [Inbound FAX routing] Item list

■ Registering, printing, and deleting originals (mailbox transmission)

This section describes the operations of the mailbox in the equipment.

□ Registering originals

You can register originals to the confidential or bulletin board mailbox in the equipment.

Tip

To register the originals to confidential or bulletin board mailbox, the confidential or bulletin board mailbox must be created in advance.

📖 P.59 “Creating, modifying, and deleting a mailbox (mailbox transmission)”

- 1 Place the original(s).**
📖 P.14 “Placing an original”
- 2 Press [Fax] on the Home screen.**
- 3 Set the transmission conditions.**
📖 P.21 “Setting the transmission conditions”
- 4 Press [Option] > [Advanced] > [ITU Mailbox].**

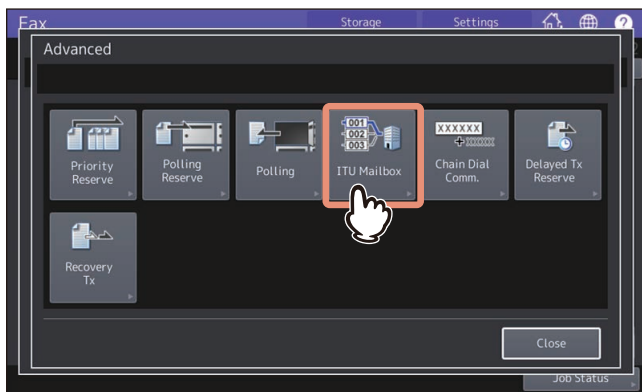

- 5 In the “Box Type” group, press [Confidential] or [Bulletin Bd.]. In the “Mode” group, press [Input], and then press [OK].**

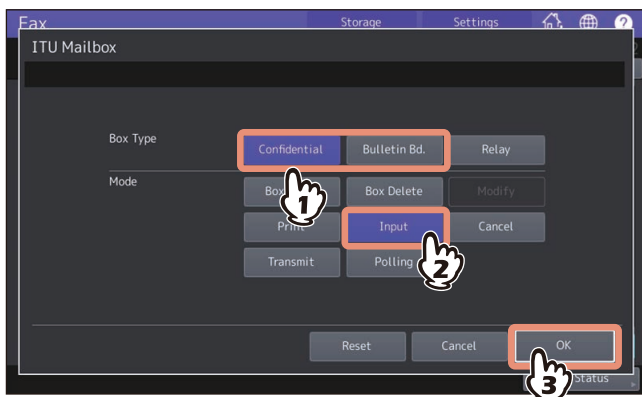

6 Key in the box number and then press [OK].

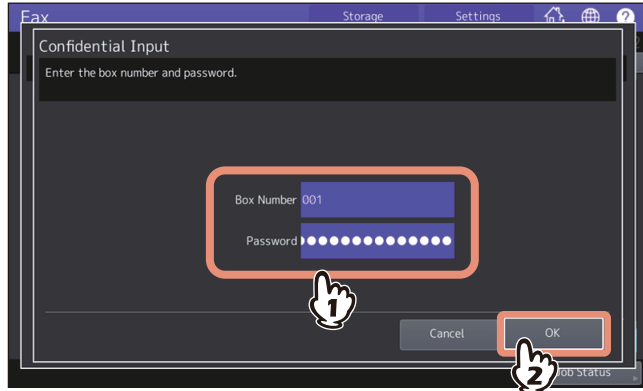

If a password has been set to the selected bulletin board mailbox, key in the password in the same way as the box number. If you have selected the confidential mailbox, it is not necessary to key in a password since it is not verified.

7 Press the [START] button on the control panel.

When you cancel the registration, press [Stop] displayed on the screen and then press [Job Cancel].

❑ Printing originals

You can print the originals registered in the confidential or bulletin board mailbox in the equipment.

1 Press [Fax] on the Home screen.

2 Press [Option] > [Advanced] > [ITU Mailbox].

3 In the “Box Type” group, press [Confidential] or [Bulletin Bd.]. In the “Mode” group, press [Print], and then press [OK].

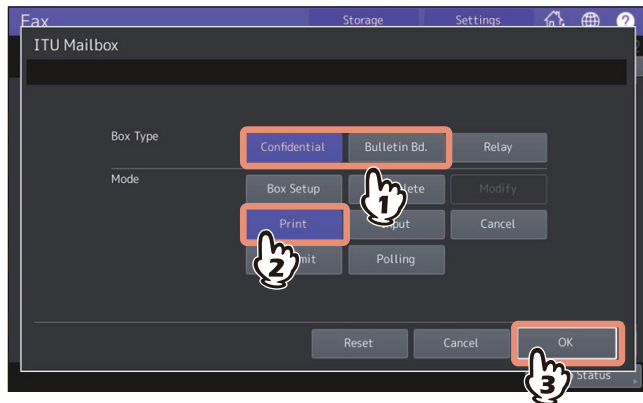

4 Key in the box number.

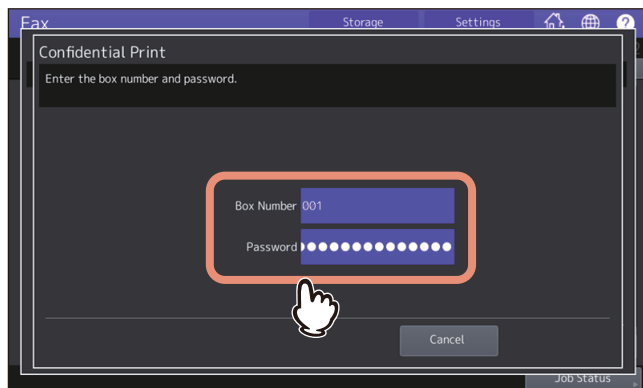

If a password has been set to the selected confidential mailbox, key in the password in the same way as the box number. If you have selected the bulletin board mailbox, it is not necessary to key in a password since it is not verified.

5 Press the [START] button on the control panel.

❑ Deleting originals

You can delete the originals registered in the confidential or bulletin board mailbox in the equipment.

- 1 Press [Fax] on the Home screen.
- 2 Press [Option] > [Advanced] > [ITU Mailbox].
- 3 In the “Box Type” group, press [Confidential] or [Bulletin Bd.]. In the “Mode” group, press [Cancel], and then press [OK].

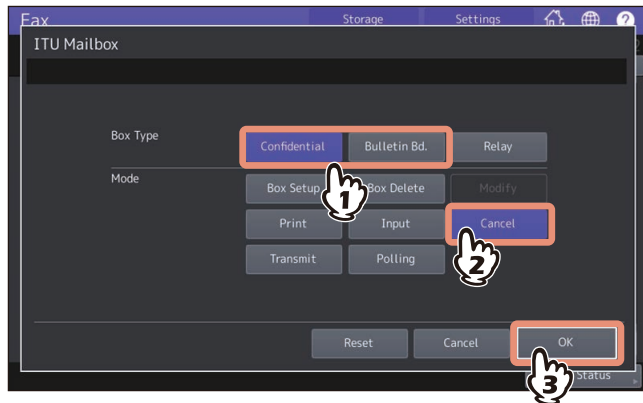

4 Key in the box number and then press [OK].

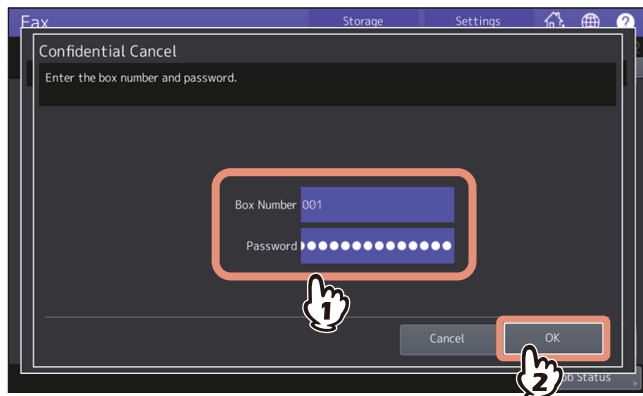

If a password has been set to the selected mailbox, key in the password in the same way as the box number.

5 The confirmation screen for the deletion is displayed. Press [Yes].

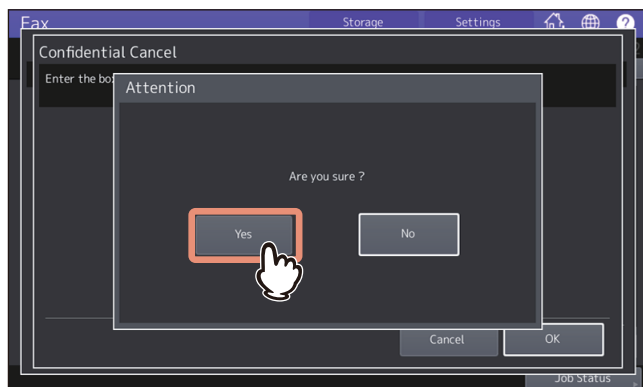

■ Sending and retrieving originals (mailbox transmission)

This section describes the operations to the mailboxes in the recipient's fax machine.

□ Sending originals

You can send originals to the confidential/bulletin board/relay station mailbox in the recipient's fax machine.

- 1 **Place the original(s).**
📖 P.14 "Placing an original"
- 2 **Press [Fax] on the Home screen.**
- 3 **Set the transmission conditions.**
📖 P.21 "Setting the transmission conditions"
- 4 **Press [Option] > [Advanced] > [ITU Mailbox].**

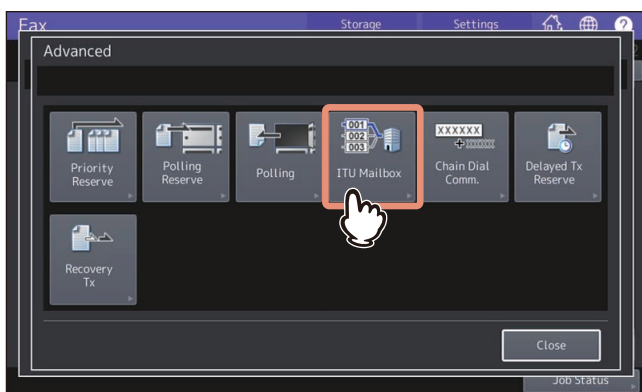

- 5 **In the "Box Type" group, press [Confidential], [Bulletin Bd.] or [Relay]. In the "Mode" group, press [Transmit], and then [OK].**

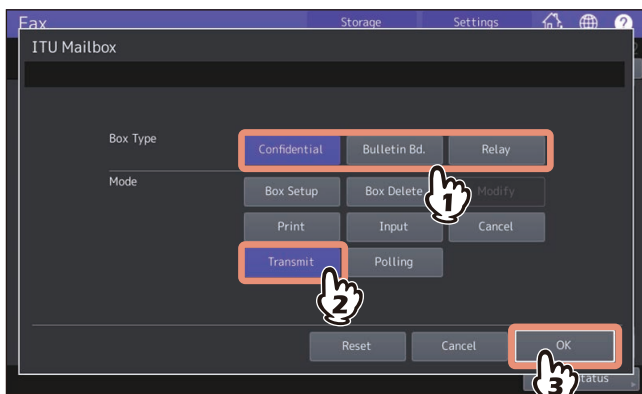

6 Key in the box number and then press [OK].

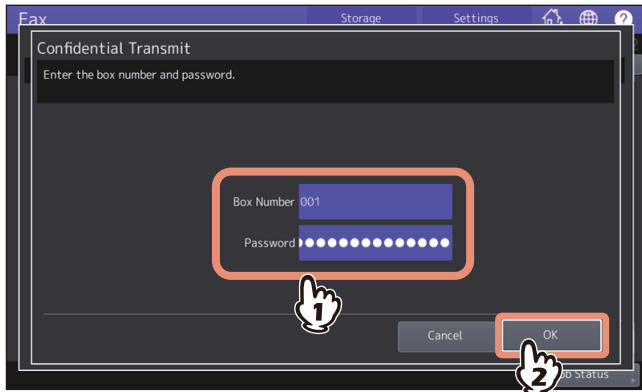

If a password has been set to the selected mailbox, key in the password in the same way as the box number.

Tip

The box number and the password you specified here are sent to the recipient's fax machine as SUD (box number) and SID (password) of the command compatible with the ITU-T standards.

7 Specify the recipient's fax number.

P.27 "Specifying the recipient"

8 Press [Send].

P.19 "Sending a Fax"

You can cancel the transmission of the original.

P.45 "Canceling the Transmission"

Retrieving originals

You can retrieve originals from the confidential or bulletin board mailbox in the recipient's fax machine.

1 Press [Fax] on the Home screen.

2 Press [Option] > [Advanced] > [ITU Mailbox].

3 In the "Box Type" group, press [Confidential] or [Bulletin Bd.]. In the "Mode" group, press [Polling], and then [OK].

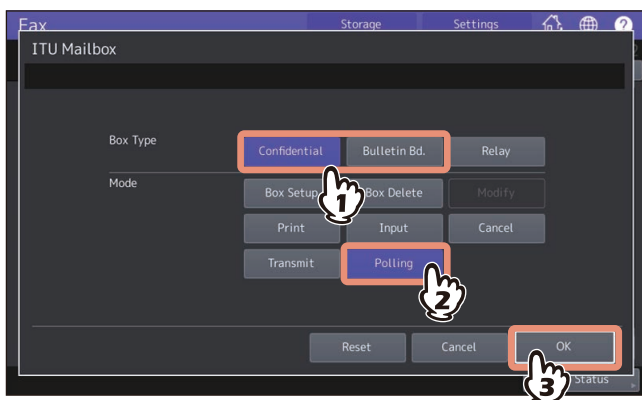

4 Key in the box number and then press [OK].

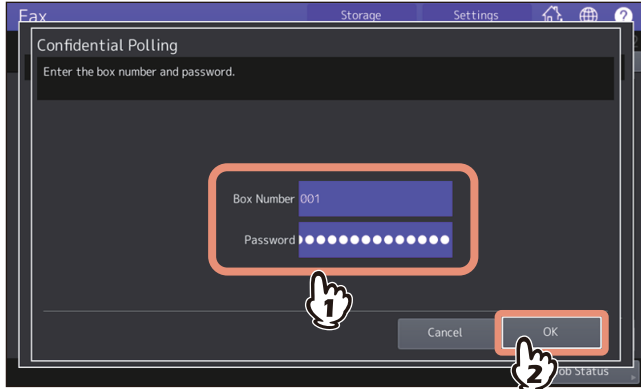

If a password has been set to the selected mailbox, key in the password in the same way as the box number.

Tip

The box number and the password you specified here are sent to the recipient's fax machine as SUD (box number) and SID (password) of the command compatible with the ITU-T standards.

5 Specify the recipient's fax number.

P.27 "Specifying the recipient"

6 Press [Send].

P.19 "Sending a Fax"

■ Creating, modifying, and deleting a mailbox (mailbox transmission)

This section describes how to manage the mailbox in the equipment.

Tip

In the list, you can view the status of the mailbox registered to the equipment.

P.123 "MAILBOX/RELAY BOX REPORT"

□ Creating the confidential or bulletin board mailbox

You can create the confidential or bulletin board mailbox in the equipment.

1 Press [Fax] on the Home screen.

2 Press [Option] > [Advanced] > [ITU Mailbox].

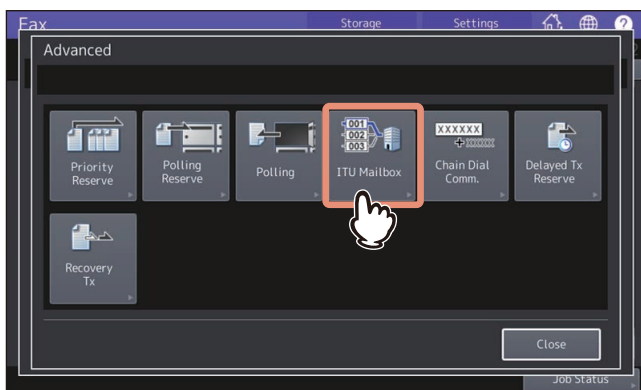

- 3** In the “Box Type” group, press [Confidential] or [Bulletin Bd.]. In the “Mode” group, press [Box Setup], and then [OK].

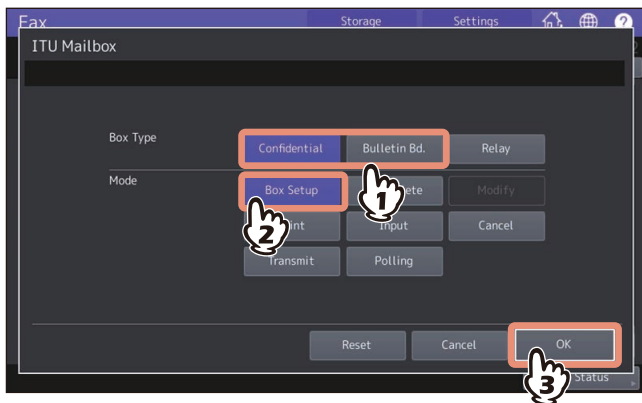

- 4** Key in the box number (a maximum of 20 digits) and then press [OK].

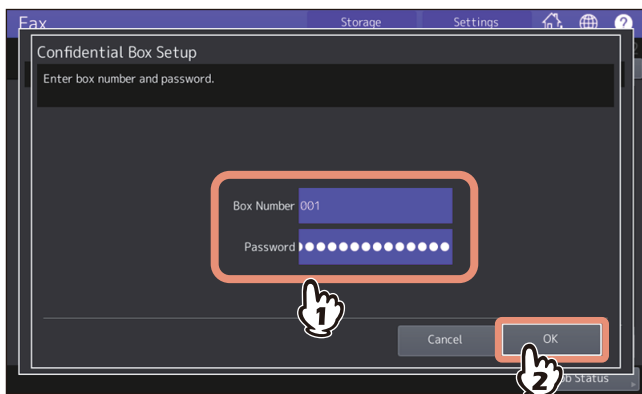

If you want to set a password (a maximum of 20 digits), key in the password in the same way as the box number.

❑ Creating/modifying a relay station mailbox

You can create or modify the relay station mailbox.

- 1** Press [Fax] on the Home screen.
- 2** Press [Option] > [Advanced] > [ITU Mailbox].
- 3** In the “Box Type” group, press [Relay]. In the “Mode” group, press [Box Setup] or [Modify], and then [OK].

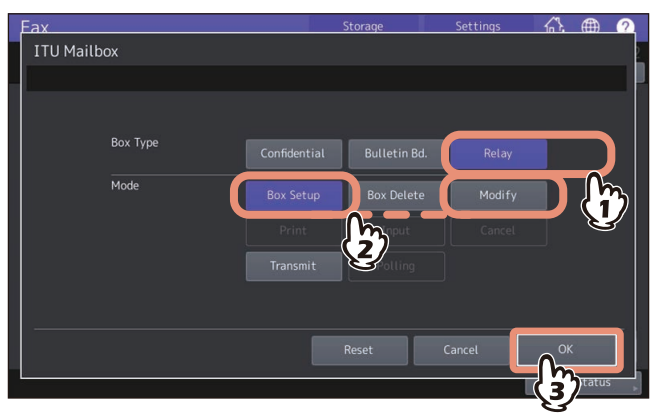

- 4** Key in the box number (a maximum of 20 digits) and then press [OK].

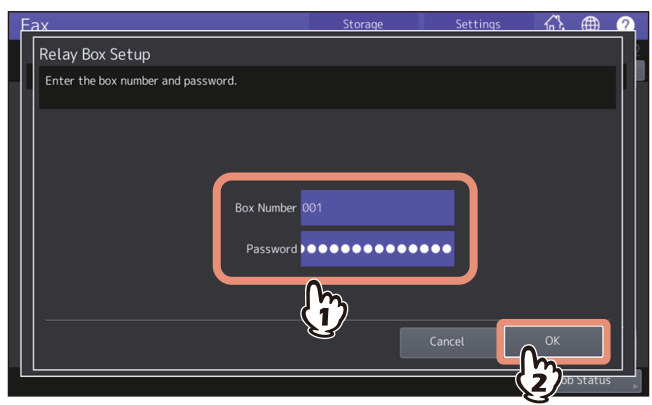

If you want to set a password (a maximum of 20 digits), key in the password in the same way as the box number.

- 5** Specify the recipient to be registered, and then press [OK].
📖 P.27 “Specifying the recipient”

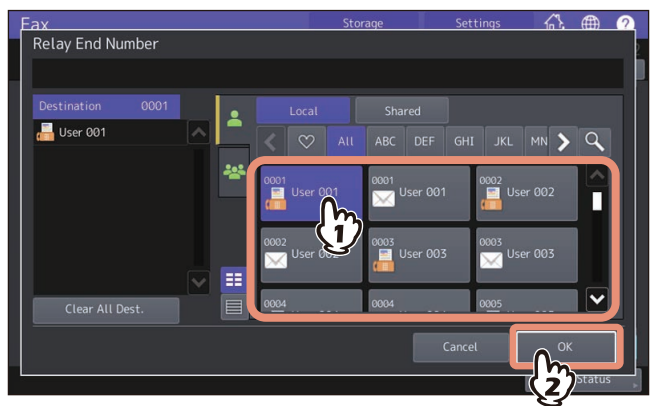

Specify the recipient from the address book because this cannot be done with direct dialing.

- 6 The confirmation screen for sending a relay transmission report is displayed. If you want to send the report, select [Yes]. If not, select [No].**

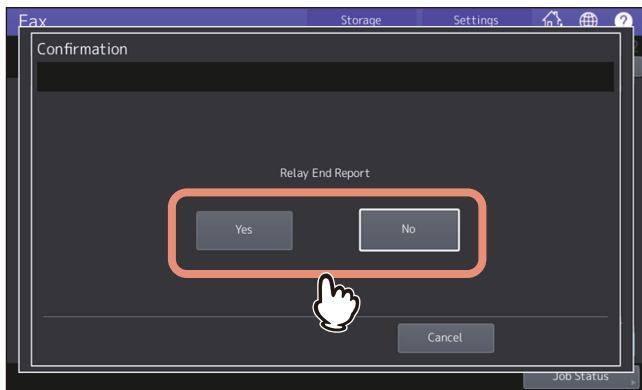

Tip

By default, the relay transmission end terminal report is sent when a communication error occurs. On the Admin menu, you can make setting so that the report can be sent automatically. For details of the operation, see the reference below:

User Functions - SETTING ITEMS (Admin) - List/Report - Setting the report - Setting the communication report

- 7 Specify the recipient to which you want to send the report, and then press [OK].**
📖 P.27 “Specifying the recipient”

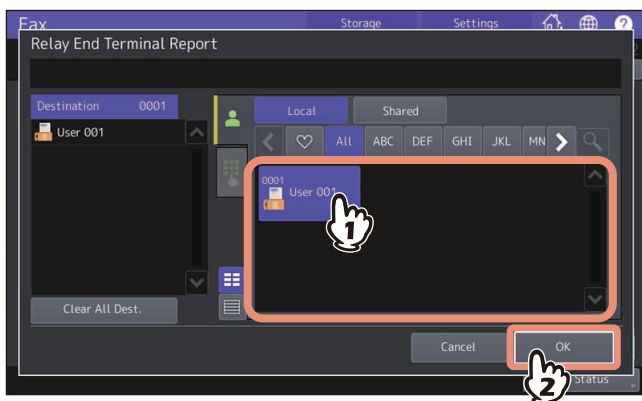

Only one recipient can be specified.

- 8 The confirmation screen for printing the received copy of the original is displayed. If you want to print it out whenever a copy of the original is delivered, press [Always]. If you want to print it out only when an error occurs, press the [On Error].**

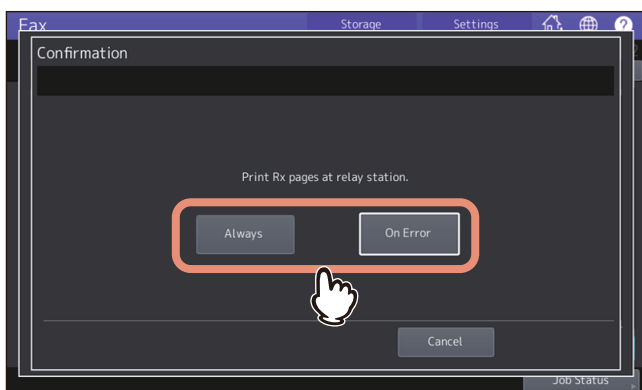

❑ Deleting a mailbox

You can delete the confidential/bulletin board/relay station mailbox registered in the equipment.

Tip

The confidential and bulletin board mailbox in which the original is registered cannot be deleted. To delete the mailbox, delete the original in advance.

📖 P.56 “Deleting originals”

- 1** Press [Fax] on the Home screen.
- 2** Press [Option] > [Advanced] > [ITU Mailbox].
- 3** In the “Box Type” group, press [Confidential], [Bulletin Bd.] or [Relay]. In the “Mode” group, press [Box Delete], and then [OK].

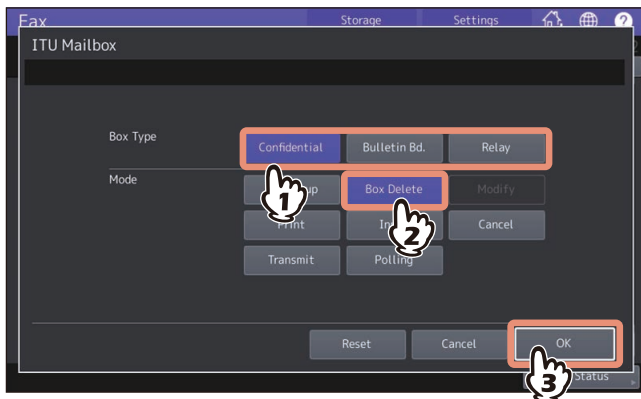

- 4** Key in the box number and then press [OK].

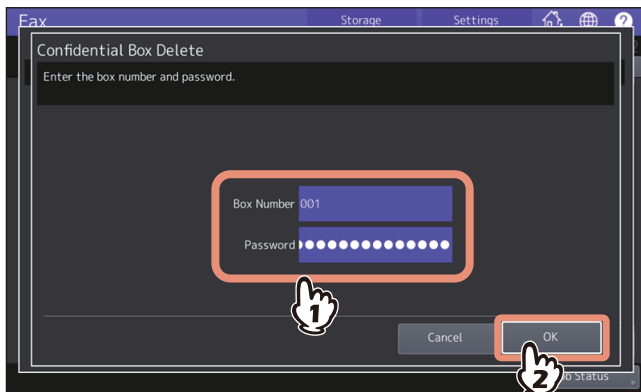

If a password has been set to the selected mailbox, key in the password in the same way as the box number.

- 5** The confirmation screen for the deletion is displayed. Press [Yes].

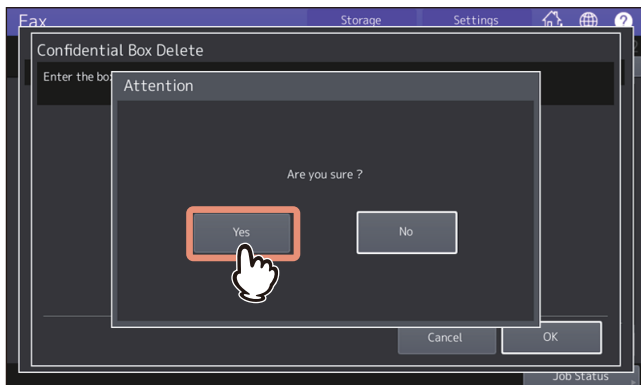

Dialing numbers by Chaining Multiple Sets of Numbers (Chain Dial Communication)

You can chain pre-registered sets of numbers to form a dialing string. For example, you can form the desired number by specifying sets of numbers registered in the address book sequentially such as region code, area code and fax numbers.

- 1 Place the original(s).**
📖 P.14 “Placing an original”
- 2 Press [Fax] on the Home screen.**
- 3 Set the transmission conditions.**
📖 P.21 “Setting the transmission conditions”
- 4 Press [Option] > [Advanced] > [Chain Dial Comm.].**

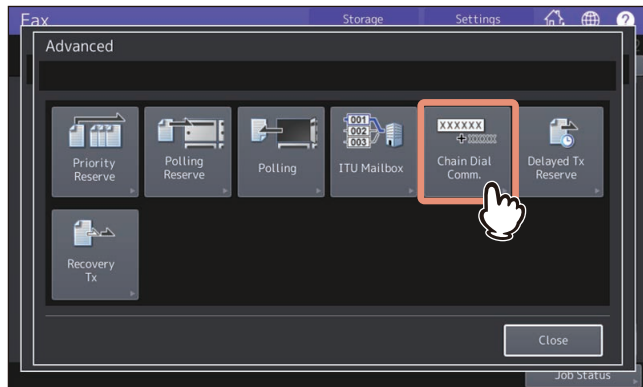

- 5 Repeat this operation until the desired number is formed.**
📖 P.27 “Specifying the recipient”

You can form the dialing number which is up to 128 digits in length. The numbers are chained in the order you specify them.

Tip

To send faxes to several recipients, press [OK] for each selection of a recipient to set the entry.

- 6 Press [Send].**
📖 P.19 “Sending a Fax”

Sending Faxes at Specified Dates and Times (Delayed Transmission Reservation)

You can send a fax at a specified date and time. It is useful when you want to make use of off-peak discounts (e.g. nighttime) or you want to send a fax to a country which has a time difference.

- 1 Place the original(s).**
📖 P.14 “Placing an original”
- 2 Press [Fax] on the Home screen.**
- 3 Set the transmission conditions.**
📖 P.21 “Setting the transmission conditions”
- 4 Press [Option] > [Advanced] > [Delayed Tx Reserve].**

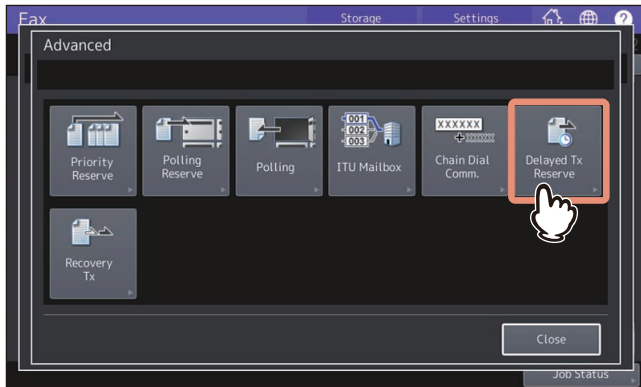

- 5 Key in the date, hour and minute, and then press [OK].**

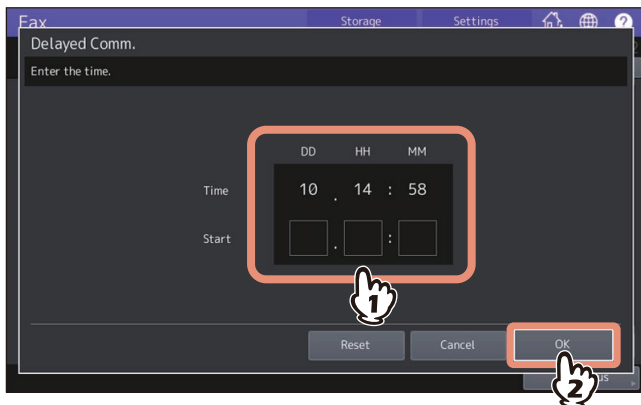

- The acceptable range of reservation is up to one month later.
- Specify the time on a 24-hour basis.

- 6 Specify the recipient's fax number.**
📖 P.27 “Specifying the recipient”
- 7 Press [Send].**
📖 P.19 “Sending a Fax”

Canceling delayed transmission reservation

You can cancel the delayed transmission reservation and send a fax in a normal manner. On the reserved transmission confirmation screen, select the transmissions job, and then press [Send].

📖 P.42 “Checking reserved transmissions”

Resending Unsent Data (Recovery Transmission)

You can save the data of originals, which were not sent after redialing a specified number of times, in the memory and resend them without placing the originals. Enabling or disabling this function or a period of time for the data to be retained can be set on the Admin menu. For the details of the current setting, ask your administrator.

- 1 Press [Fax] on the Home screen.
- 2 Set the transmission conditions.
P.21 “Setting the transmission conditions”
- 3 Press [Option] > [Advanced] > [Recovery Tx].

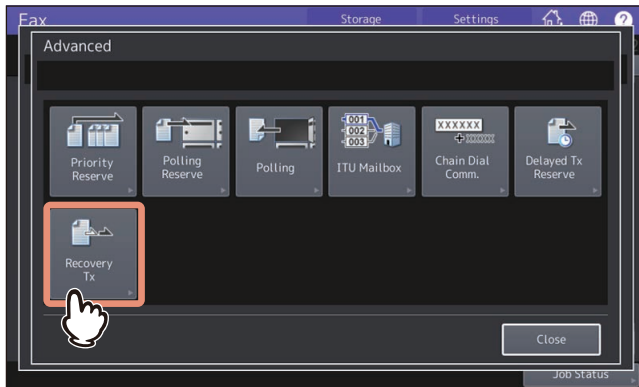

- 4 Select the transmission job, and then press [Send].

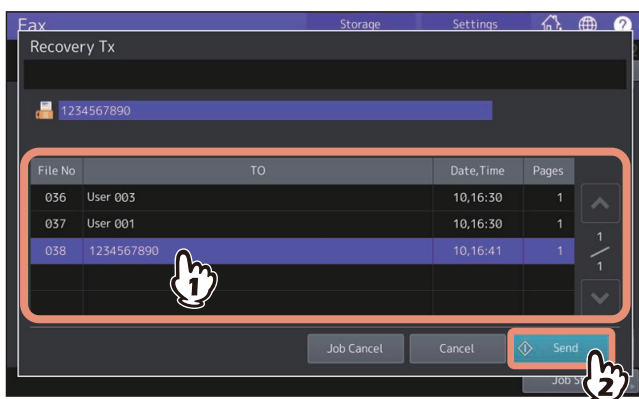

- You can change the fax number which is specified with the direct entry method.
- To delete the selected transmission job, press [Job Cancel].

E-mailing Data Received Via the Mailbox (Onramp Gateway)

The onramp gateway function allows for an original sent from another mailbox-supported fax machine to be converted into E-mail data, which will be sent to a pre-registered E-mail address, via the mailbox (relay station) in this equipment.

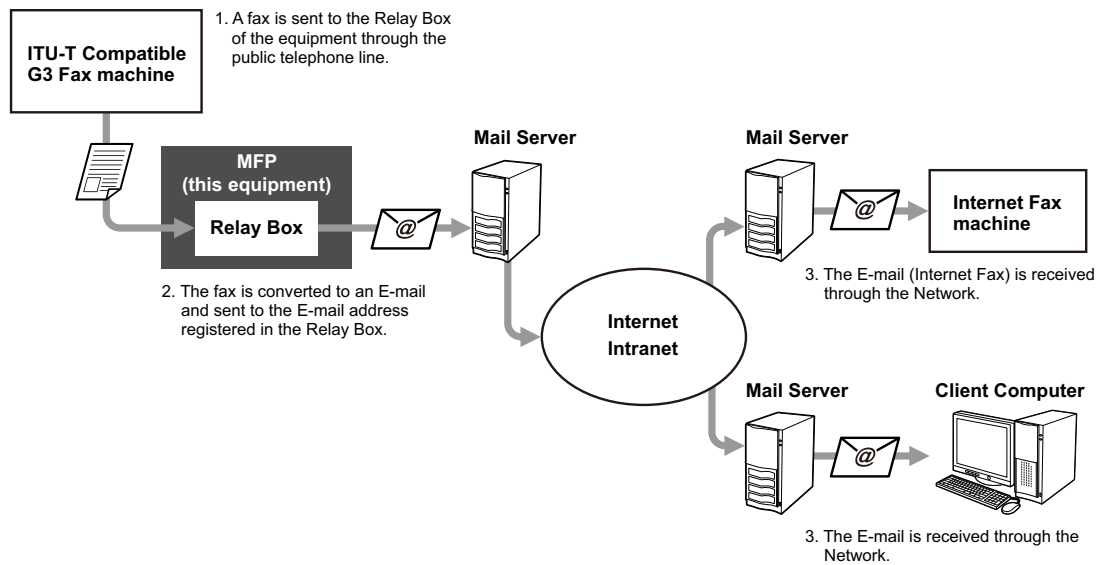

Fax numbers and E-mail addresses can be registered to the mailbox used for an onramp gateway transmission. That mailbox is the same as the one used for the mailbox transmission. For details of how to create/modify/delete a relay station mailbox, see the reference below:

P.59 “Creating, modifying, and deleting a mailbox (mailbox transmission)”

Tip

To use the onramp gateway, you need to set an E-mail address and Internet Fax to the equipment. For details, see the references below:

TopAccess - [Administration] - [Setup] Item List - Email settings

TopAccess - [Administration] - [Setup] Item List - InternetFax settings

Sending Data Received by E-mails Via the Mailbox (Offramp Gateway)

The offramp gateway function allows for E-mail or Internet Fax sent from another device to be converted into standard fax data via this equipment, which will be sent to the recipient specified by the sender via a public telephone line. This is useful in reducing communication costs by using a combination of both the Internet and public telephone lines. For example, when sending documents long distances, such as overseas, the Internet can be used to send the document to a machine in the country of destination and then it will be forwarded to a target fax machine as fax data via a public telephone line.

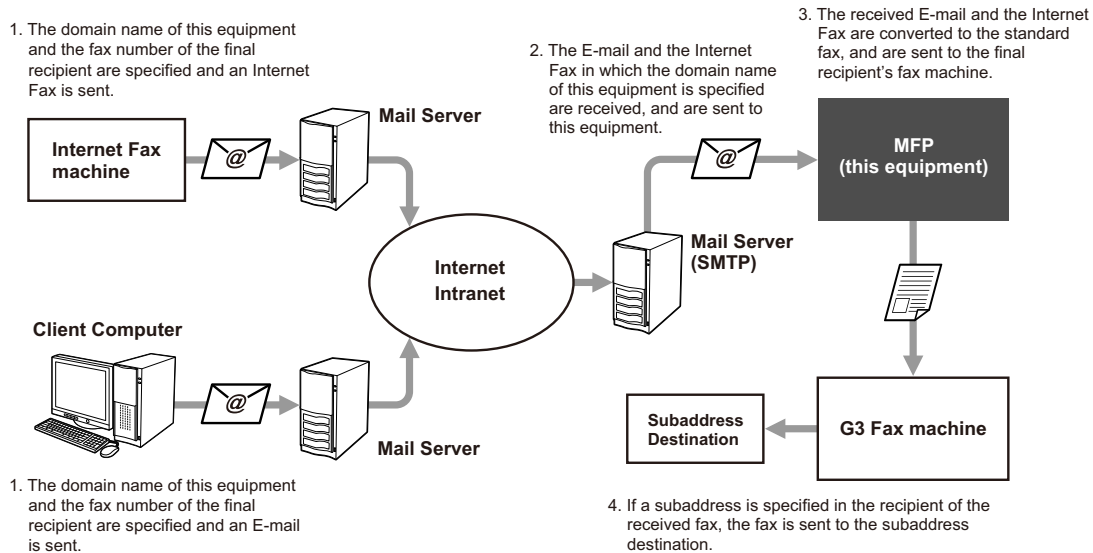

Specifying an E-mail address

When you want to use this equipment as a relay station to perform an offramp gateway transmission, ask the sender to specify an E-mail address as follows.

- FAX=xxxxxxx@FQDN
The fax number of the final recipient is specified in "xxxxxxx".
e.g.: In case that the fax number is "1234567890" and the domain name of this equipment (FQDN) is "host1.example.com", the fax should be sent to
FAX=1234567890@host1.example.com

Sending to a subaddress

- FAX=xxxxxxx/T33S=yyyy@FQDN
The fax number of the final recipient is specified in "xxxxxxx" and the subaddress in "yyyy".
e.g.: In case that the fax number is "1234567890", the subaddress is "1234", and the domain name of this equipment (FQDN) is "host1.example.com", the fax should be sent to
FAX=1234567890/T33S=1234@host1.example.com

Setting up the SMTP server

SMTP is a server protocol for sending and receiving E-mails. To use the offramp gateway function, you need to set up the SMTP server so that this equipment can receive E-mails and Internet Fax using SMTP. For details, see the reference below:

TopAccess - [Administration] - [Setup] Item List - Network settings - Setting up SMTP Server

Saving Transmitted Fax Data to the Shared Folder

While sending a fax, you can save the fax as a file to a shared folder in the equipment or in a client computer. That file can be accessed from client computers on a network. To save a fax as a file into a shared folder in a client computer, you must make the “Save as file” setting of the equipment in advance. For details, see the reference below:

TopAccess - [Administration] - [Setup] Item List - Save as file settings

Note

- Be sure to back up the files in the shared folder to protect them from unexpected data loss events.
- If the forced encryption function for PDF security* is enabled, this function is not available. For the details of the security settings, see the reference below:

User Functions - SETTING ITEMS (Admin) - Security - Setting secure PDF

* The PDF security may not be available depending on the equipment.

1 Place the original(s).

P.14 “Placing an original”

2 Press [Fax] on the Home screen and make settings as required.

3 Press [Storage].

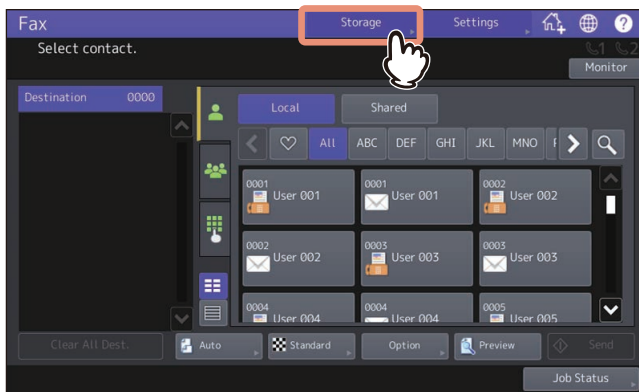

4 Select a file destination.

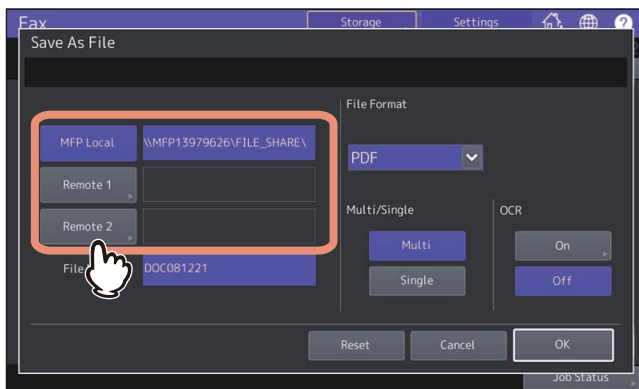

- [MFP Local] — Press this button to store files in a shared folder of this equipment.
- [Remote 1], [Remote 2] — Press this button to store files in a network folder, which is the shared folder of a computer connected with this equipment by network.

Note

Storing data in a network folder requires the administrator to set the equipment configuration. For details, see the reference below:

TopAccess - [Administration] - [Setup] Item List - Save as file settings - Setting up Destination

Tip

- If saving data in a network folder is enabled by the administrator and if the file destination is specified by the administrator, the network path for the destination is displayed on the right side of [Remote 1] or [Remote 2]. If the network path is not displayed, you need to specify a file destination. For details, see the reference below:
 P.71 “Specifying the network folder”
- If saving data in a network folder is enabled by the administrator, you can select 2 file destinations from [MFP Local], [Remote 1] and [Remote 2].

5 Make the settings for the files to be saved.

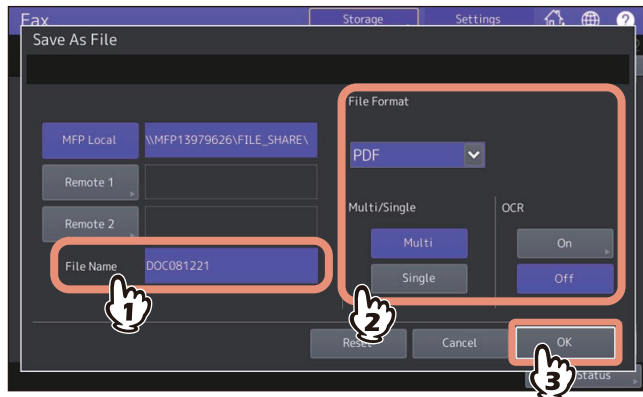

- **File Name**
The file name can consist of a maximum of 128 characters. However, the trailing characters in a file name (maximum 74) may be deleted depending on the type of letters used.
- **File Format**
 - **[PDF]** — Press this button to store your scan as a PDF file.
 - **[TIFF]** — Press this button to store your scan as a TIFF file. The OCR function cannot be used in this file format.
 - **[XPS]** — Press this button to store your scan as an XPS file. The OCR function cannot be used in this file format.
 - **[DOCX]** — Press this button to store your scan as a DOCX file. You can select this only when the OCR function is enabled.
 - **[XLSX]** — Press this button to store your scan as an XLSX file. You can select this only when the OCR function is enabled.
 - **[PPTX]** — Press this button to store your scan as a PPTX file. You can select this only when the OCR function is enabled.
- **Multi/Single Page**
 - **[Multi]** — Press this button to store your scan as a multiple page file. When you scan several pages, the equipment stores all the pages as a single file.
 - **[Single]** — Press this button to store your scan as a single file for each page. When you scan several pages, the equipment stores each page as a separate file.
- **OCR**
Press this button to enable or disable the OCR function.

Tip

- The data are saved in a shared folder with the file format which is set here. When an OCR file format is selected, it is applied to only the data saved in a shared folder.
- When a file is saved in the shared folder of the internal storage device in the MFP, it is saved in the “TXFAX” folder under the “FILE_SHARE” folder. When PDF-SINGLE, TIFF-SINGLE, or XPS-SINGLE is selected, another folder with the same file name is automatically created in the “TXFAX” folder in which the file is saved.

- It is necessary to install the OCR option to use the OCR function. For the details of the OCR function, see the reference below:

Scan - OVERVIEW - Scan Features - Scan functions - Optical Character Reader (OCR)

6 Specify the recipient's fax number.

📖 P.27 "Specifying the recipient"

7 Press [Send].

📖 P.19 "Sending a Fax"

Tip

When fax transmission is completed, storing of the data of the original is also completed. However, if a fax cannot be sent after redialing a specified number of times, only the storing of the data of the original is completed.

■ Specifying the network folder

When you are authorized to specify a file destination for the network folder, specify the destination by setting the following items. The setting items differ depending on the file transfer protocol to be used. FTP, SMB, NetWare IPX/SPX, NetWare TCP/IP and FTPS are selectable for a file transfer protocol.

Note

Storing data in a network folder requires the administrator to set the equipment configuration. For details, see the reference below:

TopAccess - [Administration] - [Setup] Item List - Save as file settings - Setting up Destination

Tip

If saving data in a network folder is enabled by the administrator, you can select 2 file destinations from [MFP Local], [Remote 1] and [Remote 2].

□ FTP / FTPS

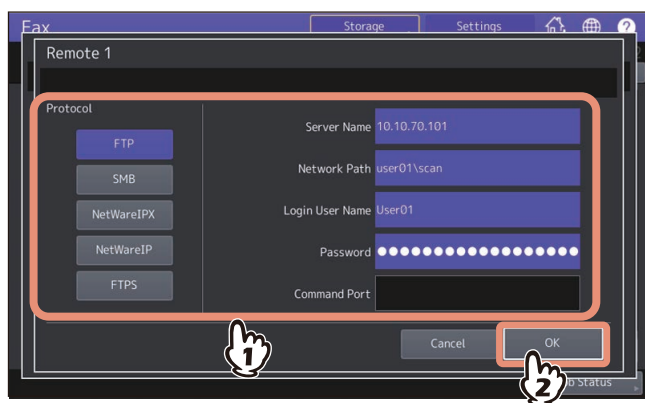

When you finish the entry, press [OK].

- **Server Name:** Enter the IP address of FTP server. For example, if the data should be transferred to an FTP folder "ftp://10.10.70.101/user01/scan/", key in "10.10.70.101".
- **Network Path:** Enter a network path to an FTP folder where the data are to be stored. For example, if the data should be transferred to an FTP folder "ftp://10.10.70.101/user01/scan/", enter "user01\scan".
- **Login User Name:** Enter a user name to login to the FTP server. Enter this as required.
- **Password:** Enter a password to login to the FTP server. Enter this as required.
- **Command Port:** Key in a command port number for executing commands. Normally "-" is entered in this field, which means that a port number set by the administrator will be used. Change this only when you want to use any other port number.

□ SMB

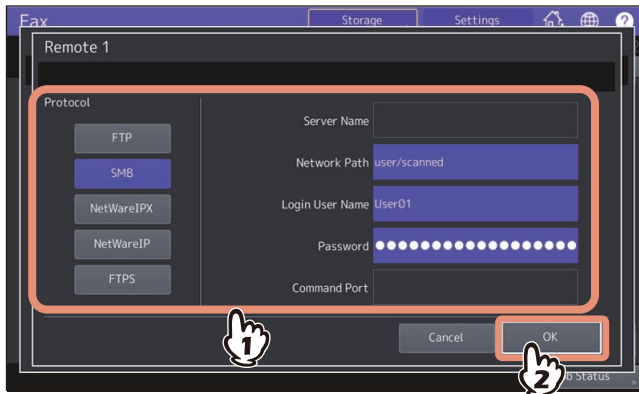

When you finish the entry, press [OK].

- **Network Path:** Enter a network path to the folder where the data are to be stored.
- **Login User Name:** Enter a user name to access the network folder. Enter this as required.
- **Password:** Enter a password to access the network folder. Enter this as required.

Tip

If you selected [SMB], the settings for [Server Name] and [Command Port] are not required.

□ NetWareIPX / NetWareIP

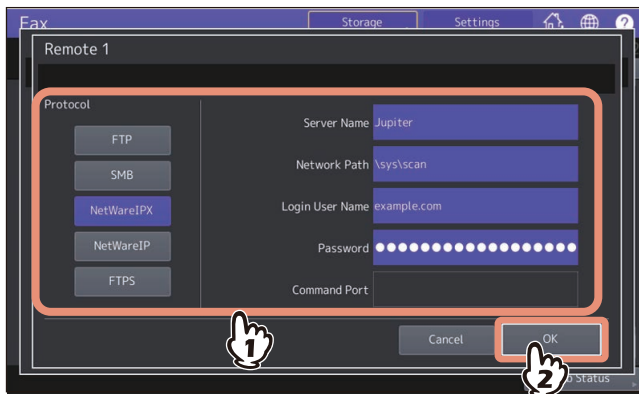

When you finish the entry, press [OK].

- **Server Name:** When you select [NetWareIPX], enter either the server name of NetWare server or Tree/Context (if NDS is usable). When you select [NetWareIP], enter the IP address of NetWare server.
- **Network Path:** Enter a network path to a NetWare server folder where the data are to be stored. For example, if the data should be transferred to a folder “sys\scan” of NetWare server, enter “\sys\scan”.
- **Login User Name:** Enter a user name to login NetWare server. Enter this as required.
- **Password:** Enter a password to login NetWare server. Enter this as required.

Printing Secure Receive fax jobs

When the PRINT DATA lamp on the control panel is lit, there is a received Secure Receive fax job. You can print the fax data by entering your Print Password.

Note

This lamp does not light when the equipment is in the Super Sleep mode.

Tip

You can display the preview of the fax image received on the touch panel before printing the fax.

📖 P.40 “Displaying the preview of a received fax”

1 Press [Print] on the Home screen.

The print screen is displayed. If you leave the screen unattended for the auto clear setting time (45 sec. by default), the screen returns to the default one automatically.

2 Select [Secure Rx (Line 1)] or [Secure Rx (Line 2)]

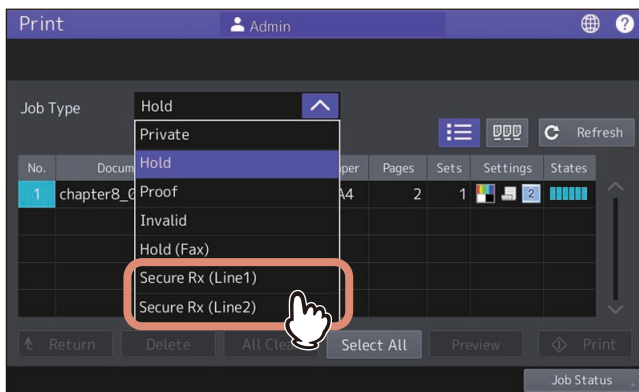

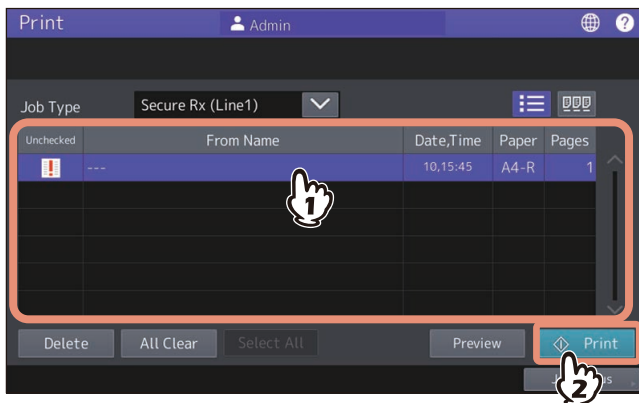

If the equipment is running in the High Security mode, [Secure Rx (Line 1)] and [Secure Rx (Line 2)] are not displayed. [Secure Rx (Line 2)] is not displayed on some models.

3 Select the desired fax job and then press [Print].



You can select and print multiple fax jobs.

Tip

- When  is pressed, received fax jobs are displayed in the list. To delete a received fax from the list, select the received file subject to delete and press [Delete].
- When  is pressed, received fax jobs are displayed in thumbnail images.
- To delete a received fax from the thumbnail, select the thumbnail image subject to delete and press [Delete].
- The entry of the password is required at the first operation of any of [Delete], [Print], [Display Image] or the thumbnail images.

4 Enter the password for printing a received Secure Receive fax. Press [OK] to start printing.

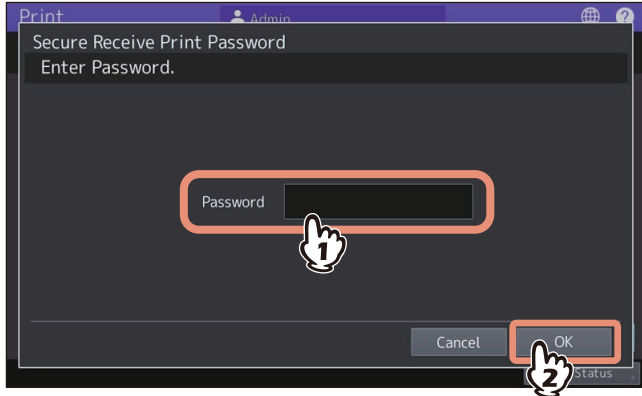

Printing Lists and Reports

■ Printing Lists & Reports Manually

You can print lists and reports (journals) manually. For samples of lists and reports, see the reference below:
 📖 P.117 “PRINTING LISTS AND REPORTS”

Tip

- Lists and reports are printed on LT/A4-size paper. If this equipment has run out of LT/A4-size paper, lists and reports will be printed on larger sized paper.
- In addition to the lists described in this section, the following lists can be printed manually.
 ADDRESS BOOK INFORMATION: List of recipients registered in the address book.
 GROUP NUMBER INFORMATION: List of recipients registered in the address book as a group.
 FUNCTION LIST: List of the user settings.
 For details, see the reference below:
User Functions - SETTING ITEMS (User) - List

□ Journal (transmission journal/reception journal)

You can print a list of transmissions and receptions.

Tip

This equipment logs up to the latest 40 or 120 transmission/reception records. This number can be set on the Admin menu. For details, see the reference below:

User Functions - SETTING ITEMS (Admin) - List/Report - Setting the report - Setting the transmission / reception journal output

1 Press [Job Status].

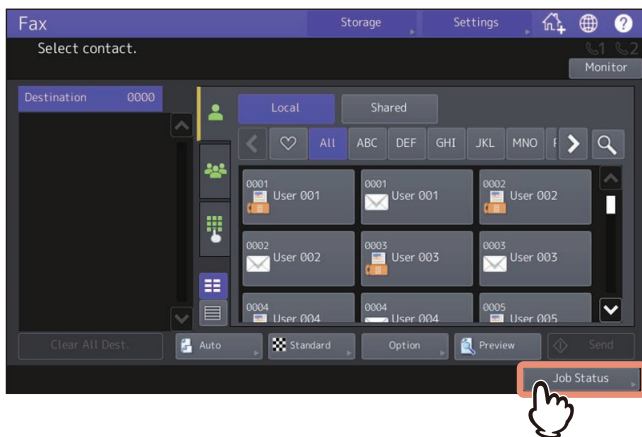

2 Select the [Log] tab, and then press [Send] or [Receive].

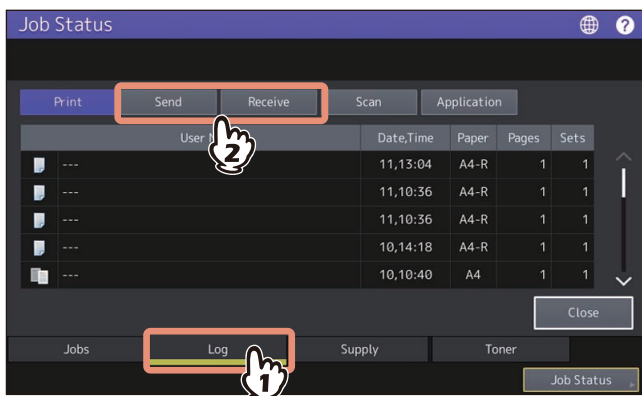

3 Press [Journal].

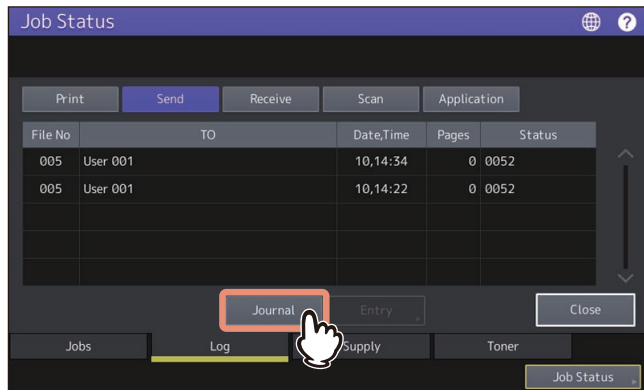

If [Journal] is pressed with the transmission/reception records selected, the journal of the selected file is printed.

❑ Reservation list

You can print a list of the reserved transmissions.

1 Press [Job Status].



2 Press the [Fax], and then press [Reservation List].

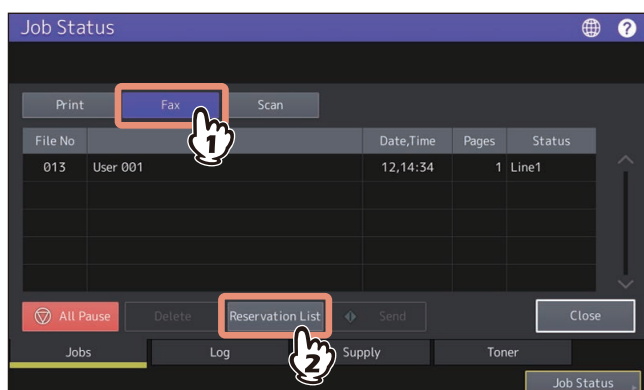

■ Printing Lists & Reports Automatically

You can print lists and reports automatically. For samples of lists and reports, see the reference below:

📖 P.117 “PRINTING LISTS AND REPORTS”

Tip

Lists and reports are automatically printed according to the settings that the administrator made, so no user operation is required. For details of the setting operation, see the reference below:

User Functions - SETTING ITEMS (Admin) - List/Report

The available lists/reports to be printed automatically are as follows:

TRANSMISSION JOURNAL

When this equipment completes 40 or 120 transmission jobs, the transmission journal is printed.

RECEPTION JOURNAL

When this equipment completes 40 or 120 reception jobs, the reception journal is printed.

MEMORY TRANSMISSION REPORT

When the memory transmission is completed, the report is printed. (You have an option to add a reduced image of the transmitted document.)

TRANSMISSION REPORT

When the direct transmission is completed, the report is printed.

MULTI TRANSMISSION REPORT

When the multi-address transmission is completed, the report is printed. (You have an option to add a reduced image of the transmitted document.)

MULTI POLLING REPORT

When a multi-polling Rx is completed, the report is printed.

RELAY TX ORIG. TERMINAL REPORT

When the document transmission from an originator terminal to a relay station is completed during the mailbox transmissions, the report is printed. (You have an option to add a reduced image of the transmitted document.)

RELAY TX RELAY STATION REPORT

When a document transmission from a relay station to an end terminal is completed during the mailbox transmissions, the report is printed. (You have an option to add a reduced image of the transmitted document.)

RELAY TX END TERMINAL REPORT

When the document transmission from a relay station to an end terminal is completed during the mailbox transmissions, the report is sent to an originator terminal. (You have an option to add a reduced image of the transmitted document.)

RELAY STATION REPORT

When a relay station in this equipment receives an original during the mailbox transmissions, the report is printed.

MAILBOX RECEPTION REPORT

When the confidential or bulletin board mailbox in this equipment receives an original during the mailbox receptions, the report is printed.

USING N/W-FAX DRIVER (NETWORK FAX)

Overview of the Network Fax Features	80
Sending Network Faxes	81
When password entry is required	82
When LDAP authentication is enabled	83
Specifying Recipients of Network Faxes	84
Entering recipients from the keyboard.....	84
Selecting recipients from the address book.....	86
Selecting recipients from the address book (Search option)	87
Removing recipients	92
Setting up the N/W-Fax Driver	93
Making the initial settings of the N/W-Fax driver options.....	93
Setting print options for each print job	93
Setting up the N/W-Fax Driver Options	94
Setting up the [Layout] tab.....	94
Setting up the [Send] tab.....	95
Setting up the Cover Sheet.....	97
Setting up the SNMP	98
Setting up the [Device Settings] tab	100
Customization: [Language] tab.....	102
Setting up LDAP servers.....	103
Sending With Extended Fax Functionality.....	104
Saving a fax as a file	104
Delayed transmission reservation	105
Sending with a cover sheet	106

Overview of the Network Fax Features

This equipment provides the network fax features, which simplify and facilitate your office facsimile needs and enables you to send fax or Internet Fax digital documents directly from your desktop.

Note

- Fax transmission using the N/W-Fax driver is available only when the FAX unit is installed.
- Please enable the SNMP setting on TopAccess to use the N/W-Fax functions. In addition, the N/W-Fax driver does not work if the SNMP setting on TopAccess is disabled when the optional FAX unit is installed.

The N/W-Fax driver and the AddressBook Viewer are the network fax utilities which are the client software of this equipment.

The highly intuitive, N/W-Fax driver enables you to select the fax printer driver to electronically fax or Internet Fax from your computer to one or more recipients. By the combination with the AddressBook Viewer, you can easily manage a selection of fax recipients and access to the address book.

The N/W-Fax driver enables you to set up send lists and send electronic documents from your computer to one or more destinations. You send to the fax in much the same way you would choose to print to a designated printer that makes using the N/W-Fax driver quick and simple. You can select the fax properties. Fax properties are the attributes you can set to define sender and recipient information for processing fax jobs such as dialing options, sender information, fax resolution and page layout.

Other features include an easy-to-use fax scheduler that allows you to set up a date and time to transmit your fax. Cover page options are also provided. You can include a customized cover page with your fax transmission that can contain sender and recipient fax information and a detailed message. You can easily maintain sender and contact information that can be printed on the cover pages.

Note

Faxing paper documents must be performed by using the fax function from the touch panel of the MFP.

Tip

- The image quality of the originals that are sent by the N/W-Fax driver is different from the originals that are sent by the general fax operation.
- If you specify the Email addresses as the recipients using the N/W-Fax driver, the document will be sent as an Internet Fax. The Internet Fax feature allows users to send originals the same as the fax features. However, an Internet Fax is sent through the Internet, although a fax is sent through the public switched telephone line. In order to send an Internet Fax, the remote device also must support the Internet Fax feature.

Sending Network Faxes

The basic procedure for sending a fax (Network Fax / Internet Fax) is as follows.

You can use standard functions or set optional functions as well as the basic ones described in this section. For these operations, see the reference below:

📖 P.93 “Setting up the N/W-Fax Driver”

- 1 Start the application software and prepare the document to be sent.**
- 2 Select [Print] from the [File] menu in the application software.**

Tip

The procedure for displaying the [Print] dialog box may differ from the above depending on the application software.

- 3 Select [TOSHIBA e-STUDIO Fax] for the printer and click [Preferences].**

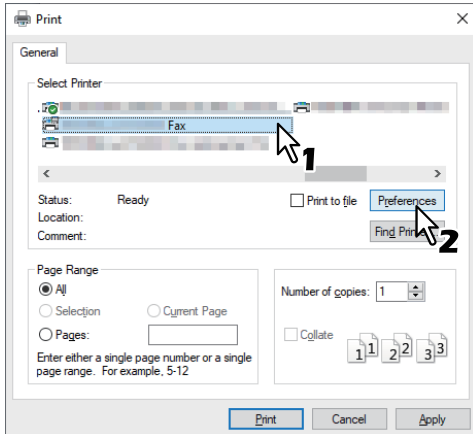

The dialog box of the N/W-Fax driver properties appears.

Tip

Note that the command name to open the driver properties may differ from [Preferences] depending on the application software.

- 4 Click the [Send] tab and specify the recipients.**

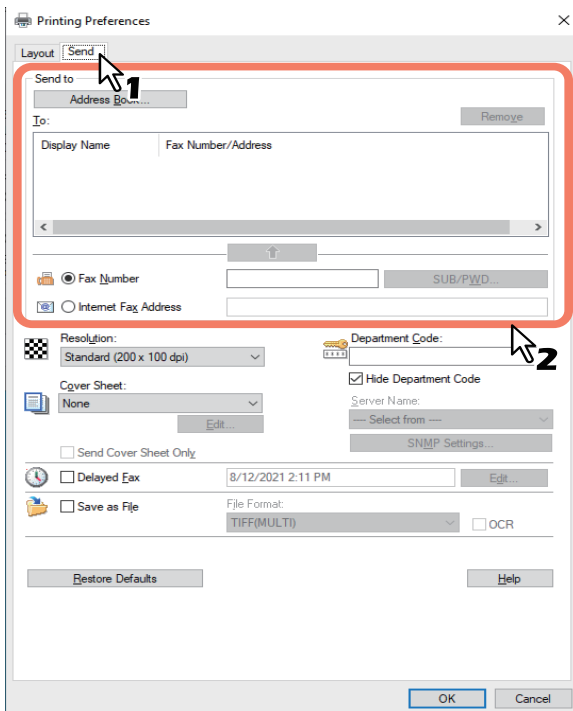

- To specify recipients, enter them with the keyboard or select them from the address book.
 P.84 “Specifying Recipients of Network Faxes”
- On the [Send] tab, you can set the resolution of a fax cover sheet, etc. as well as specifying the recipients.
 P.95 “Setting up the [Send] tab”
- On the [Layout] tab, you can set the size and the orientation of the paper.
 P.94 “Setting up the [Layout] tab”

5 Confirm the recipients and click [OK].

The transmission settings are determined and the N/W-Fax driver properties dialog box is closed.

6 Click [Print] in the [Print] dialog box.

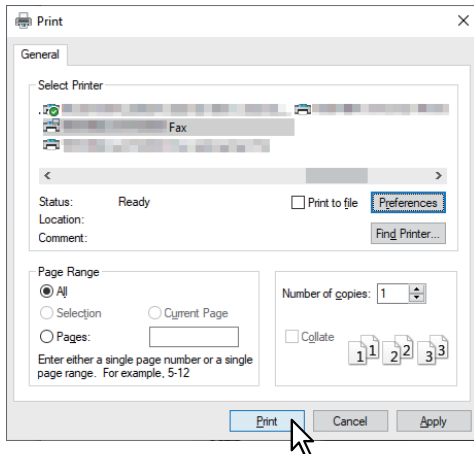

A fax is sent.

Tip

- Note that the command name to print a document (send a fax) may differ from [Print] depending on the application software.
- A waiting fax job can be checked or deleted through the managing jobs function in TopAccess. A sent fax job can also be checked through the displaying job logs function in TopAccess. For details, see the references below:

TopAccess - [Job Status] - [Job Status] Overview - [Fax/InternetFax Job] Item list
TopAccess - [Logs] - [Logs] Overview - [View Logs] Item list - Transmission Journal

■ When password entry is required

When the [Enter the user credentials manually] option is enabled on this equipment, you are prompted to enter your user name and password before sending a fax.

When the dialog box appears, enter your user name and password, and then click [OK].

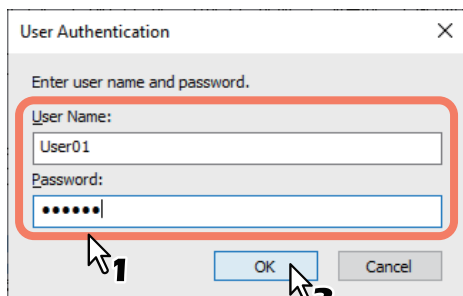

Tip

- Up to 128 characters can be entered in the [User Name] box. Up to 64 characters in the [Password] box.
- The user name and password entered in the above boxes are not stored. Therefore, you must enter your user name and password every time you send a fax.
- If you want to change the settings of this option, carry it out on the [Device Settings] tab.
 P.100 “Setting up the [Device Settings] tab”

■ When LDAP authentication is enabled

When LDAP authentication is enabled on this equipment, you must specify an LDAP server in the [Server Name] box on the [Send] tab before sending a fax.

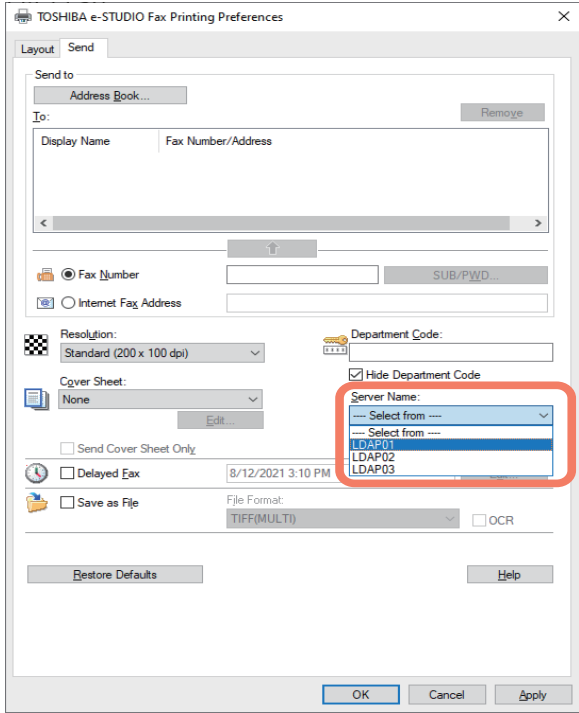

If you attempt to send a fax without specifying an LDAP server, the [Specify LDAP Server] dialog box will appear to ask you to do so.

In this case, specify the desired LDAP server in the [Server Name] box and click [OK] to send the fax.

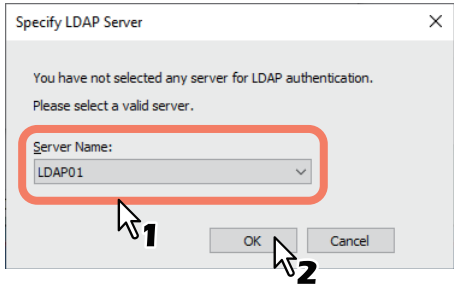

Tip

If you want to change the settings of an LDAP authentication, carry it out on the [Device Settings] tab.
 P.100 “Setting up the [Device Settings] tab”

Specifying Recipients of Network Faxes

Up to 400 recipients can be specified in a single operation.

To send a Network Fax, specify the fax number. To send an Internet Fax, specify the Email address.

Note

- If more than one recipient is specified in a single transmission, and a cover sheet is set in the N/W-Fax driver or a header page is set to be printed on the recipient's device, all the recipient information may be printed. If you want to secure the recipient information, avoid sending a fax to multiple recipients at the same time.
- When you update the address book of this equipment, collect its data from AddressBook Viewer and synchronize them to the latest status.

Tip

To use the address book, you need to register recipients in the address book of AddressBook Viewer in advance.

■ Entering recipients from the keyboard

You can enter a recipient with the keyboard.

1 Select the entry method of a recipient to enter its fax number or Email address.

- For the recipient of a Network Fax, select the [Fax Number] check box and enter the fax number in the right-hand box.
- For the recipient of an Internet Fax, select the [Internet Fax Address] check box and enter the Email address in the right-hand box.

The screenshot shows the 'TOSHIBA e-STUDIO Fax Printing Preferences' dialog box, specifically the 'Send' tab. The 'Send to' section has an 'Address Book...' button and a 'Remove' button. Below that is a table with columns for 'Display Name' and 'Fax Number/Address'. The 'Fax Number' radio button is selected, and the 'Internet Fax Address' radio button is unselected. The 'Fax Number' field contains '12345697890'. The 'Internet Fax Address' field is empty. A red box highlights the 'Fax Number' and 'Internet Fax Address' fields. Other settings include Resolution: Standard (200 x 100 dpi), Department Code: (empty), Hide Department Code: checked, Server Name: Select from, Send Cover Sheet Only: unchecked, Delayed Fax: unchecked, File Format: TIFF(MULTI), and OCR: unchecked. Buttons for 'Restore Defaults', 'Help', 'OK', 'Cancel', and 'Apply' are visible at the bottom.

Tip

- Use “ - ” (hyphen) if you send a Network Fax with pauses (approx. 3 seconds) inserted in the fax number.
- When you enter a fax number, you can also enter a sub address and a password. Click [SUB/PWD] to enter them (within 20 digits each) in the dialog box. Entering them enables the document to be transferred from the recipient’s device to that of the sub-address, as the communication is in compliance with ITU-T standard. However, in order to use this function, the recipient’s device must be a model in compliance with the ITU-T standard.

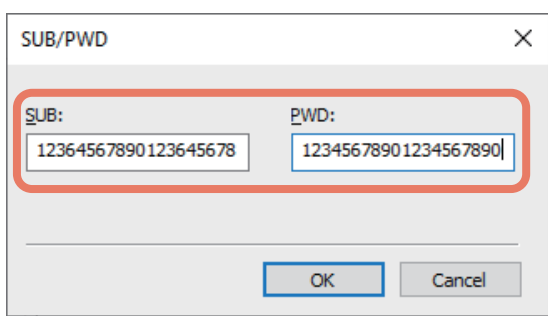

2 Click .

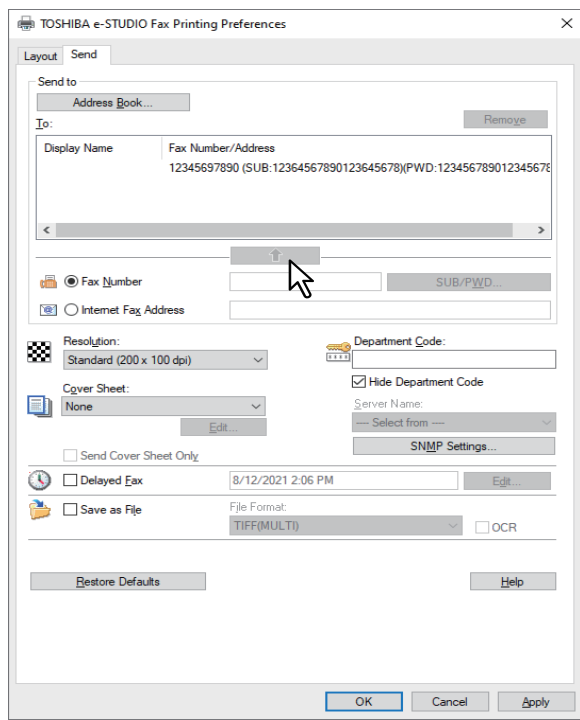

The recipients selected for “To” are listed.
 To send faxes to several recipients, repeat steps 1 and 2 to add the necessary fax numbers or Email addresses to the list.

Tip

When the fax transmission is completed, the recipients are automatically removed from the “To” list.

■ Selecting recipients from the address book

Select recipients from the address book in the AddressBook Viewer.

1 Click [Address Book].

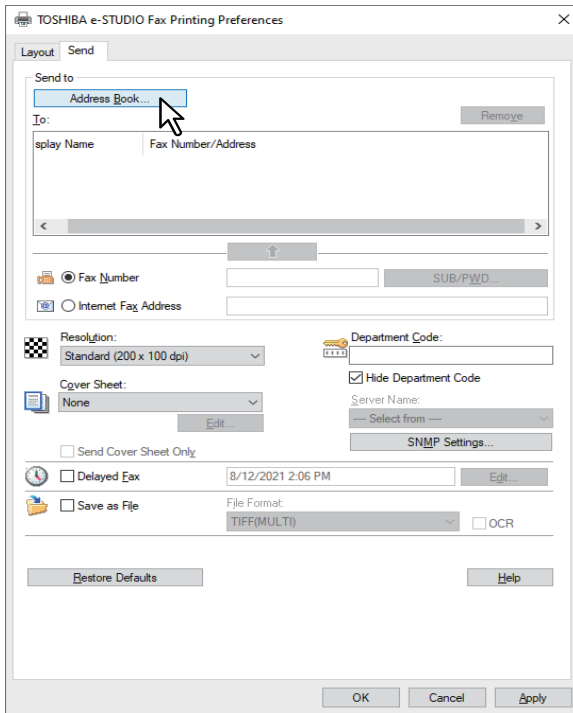

The AddressBook Viewer runs.

2 Select a recipient from the contact list and add it to the list below.

- When selecting the recipient with the fax number, click [Select Fax].
- When selecting the recipient with the Email address, click [Select Email].

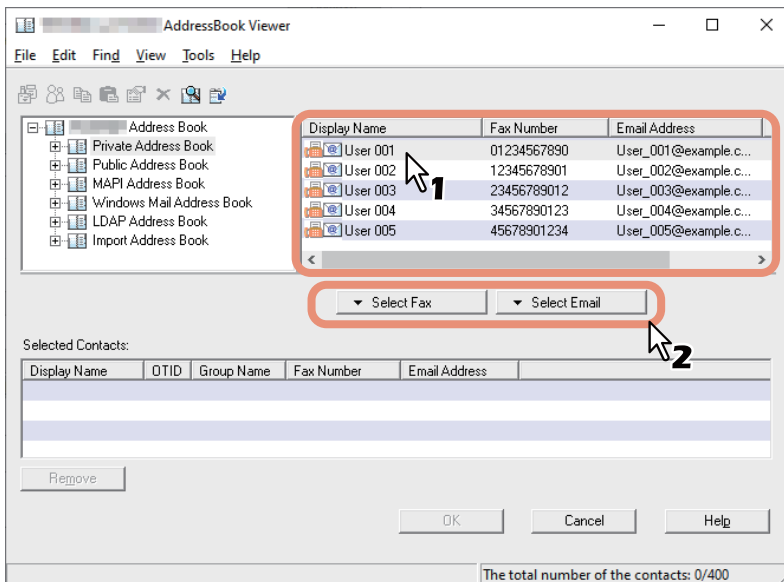

The selected recipients are listed in the “Selected Contacts”.

To send faxes to several recipients, repeat the above steps to add the necessary fax numbers or E-mail addresses to the lists.

Note

A contact, for which only a fax number is registered, cannot be displayed in the “Email Address” and a contact, for which only an Email address is registered, cannot be displayed in the “Fax Number”.

You can select a recipient by the following operations:

- **Selecting a contact by dragging and dropping**
 Drag a contact in the contact list and drop it to [Selected Contacts] and then select [Fax Number] or [Email Address] from [Select].
- **Selecting a contact by double-clicking on it**
 Double-click on a contact in the contact list. Since [Email] is set as the factory default, only the Email address of the recipient selected by double-clicking on a contact is displayed in “Selected Contacts”. To change the setting of the recipient to be selected upon double-clicking, select [Default Configuration], [Type Selection] in the [View] menu and then one of [Fax], [Email] and [Both].
- **Selecting a contact from a shortcut menu**
 Right-click on the contact in the contact list, select [Select] from the shortcut menu and then either [Fax Number] and [Email].
- **Removing a recipient**
 Select a recipient in the “Selected Contacts” and click [Remove].

3 Confirm the recipients and click [OK].

The AddressBook Viewer is closed and the recipients selected for “To” are listed.

Tip

When the fax transmission is completed, the recipients are automatically removed from the “To” list.

■ Selecting recipients from the address book (Search option)

You can find and select a recipient from the address book in the AddressBook Viewer.

1 Click [Address Book].

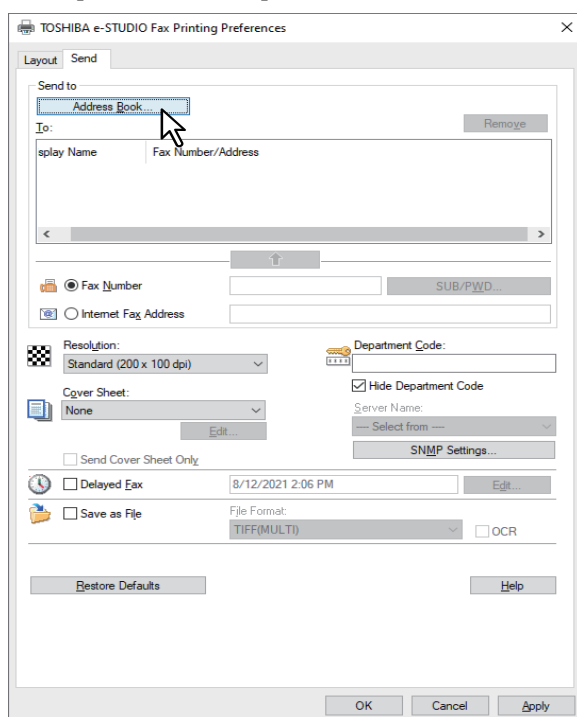

The AddressBook Viewer runs.

2 Click the [Find] menu.

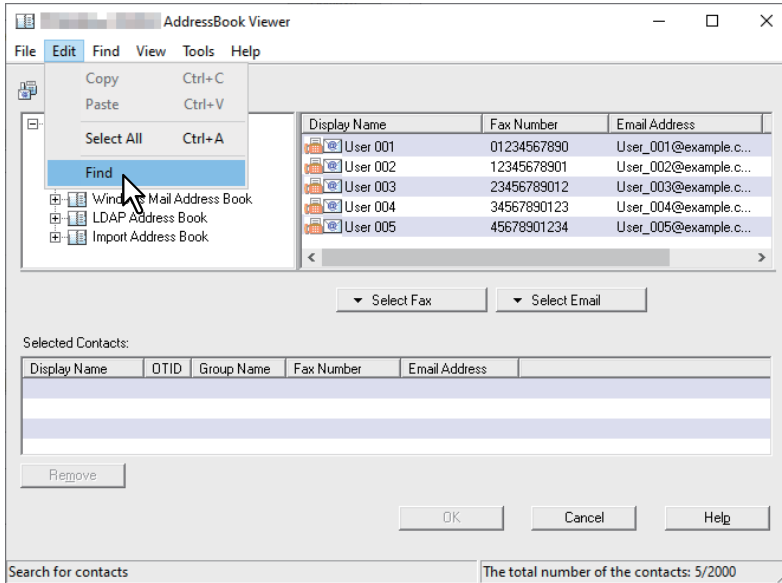

The [Find Contact] dialog box appears.

3 Select an address book in [Data Source].

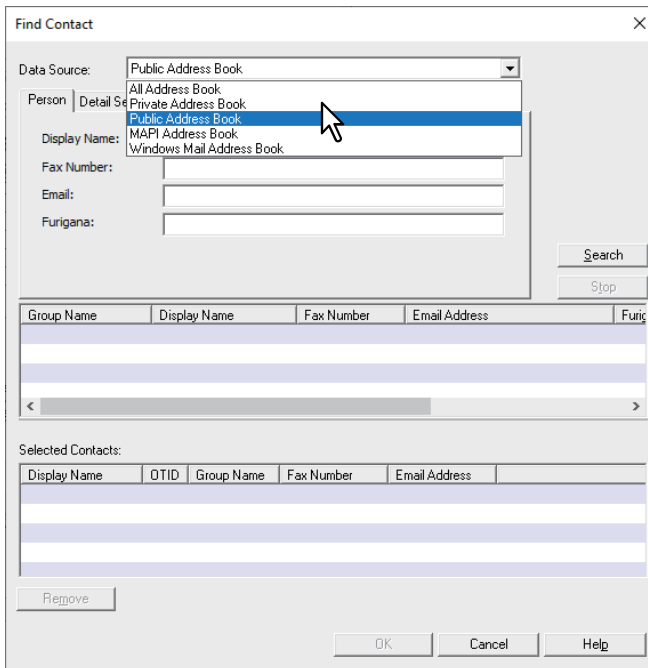

Tip

To change the setting of the default address book in the [Data Source] box, select [View] - [Default Configuration] - [Data Source] and then choose an address book.

4 Display the [Person] tab and enter search strings in the following boxes.

Find Contact

Data Source: Public Address Book

Person | Detail Setting

Display Name: Person

Fax Number:

Email:

Furigana:

Search

Stop

Group Name	Display Name	Fax Number	Email Address	Furigana

Selected Contacts:

Display Name	OTID	Group Name	Fax Number	Email Address

Remove

OK Cancel Help

- **Display Name** — To search display names, enter a search string here.
- **Fax Number** — To search fax numbers, enter the numbers here.
- **Email** — To search Email addresses, enter a search string here.

If you perform searching in the above conditions, proceed to step 6. If you want to set more detailed search conditions, proceed to step 5 and set them in the [Detail Setting] tab. However, note that even if you enter the search conditions in both the [Person] and [Detail Setting] tabs, you cannot perform searching in this combination at one time.

Tip

In the [Person] tab, you do not have to fill in all the boxes and the string does not need to completely correspond to the target of the search. Entering one or more characters in one or more boxes causes a search to be made for contacts which correspond to the particular conditions.

5 Display the [Detail Setting] tab, set the search conditions, and then click [Add].

Find Contact

Data Source: Public Address Book

Person Detail Setting

Define Condition:

Field Select: Condition of search string:

Display Name Contains User

Condition list:

Add Remove

Search Stop

Group Name	Display Name	Fax Number	Email Address	Funic
------------	--------------	------------	---------------	-------

Selected Contacts:

Display Name	OTID	Group Name	Fax Number	Email Address
--------------	------	------------	------------	---------------

Remove

OK Cancel Help

- **Field Select** — Select an item to be searched.
- **Condition of search string** — Select a condition in the left-hand box, and then enter a search string in the right-hand box.

The search condition is displayed in the “Condition list”.

To set more than one search condition, repeat this operation as many times as needed.

To delete the search conditions, select one and click [Remove].

6 Click [Search].

Find Contact

Data Source: Public Address Book

Person Detail Setting

Define Condition:

Field Select: Condition of search string:

Display Name Contains

Condition list:

Display Name Contains User

Add Remove

Search Stop

Group Name	Display Name	Fax Number	Email Address	Funic
------------	--------------	------------	---------------	-------

Selected Contacts:

Display Name	OTID	Group Name	Fax Number	Email Address
--------------	------	------------	------------	---------------

Remove

OK Cancel Help

It starts searching contacts in the selected address book. When the search is complete, the contacts matching the search conditions are listed.

To stop searching, click [Stop].

Note

Even if you enter the search conditions in both the [Person] and [Detail Setting] tabs, only the search conditions in the tab currently displayed is used. You cannot perform searching in the combined conditions on both tabs.

7 Drag and drop the contacts to “Selected Contacts” from the list of the search results.

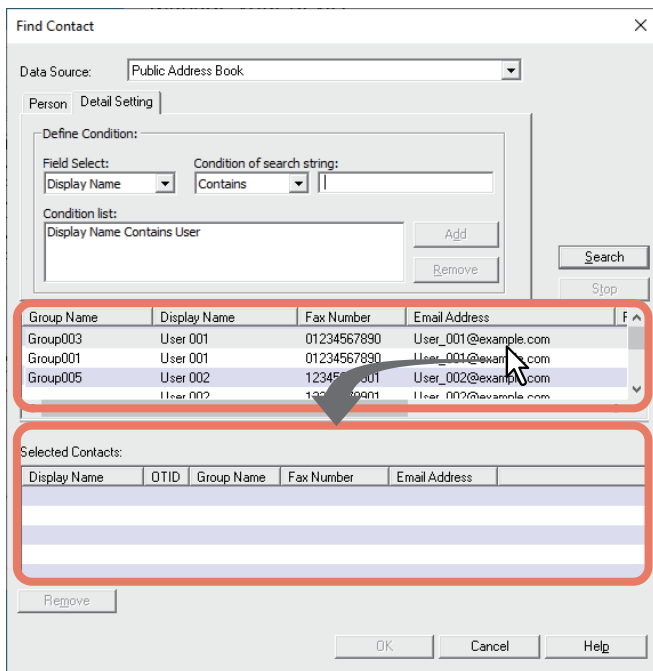

8 Select of [Fax Number] or [Email Address] from [Select].

The selected recipients are listed in “Selected Contacts”.

To send faxes to several recipients, repeat steps 1 through 8 to add the necessary fax numbers or Email addresses to the list.

Note

A contact, for which only a fax number is registered, cannot be displayed in the “Email Address” and a contact, for which only an Email address is registered, cannot be displayed in the “Fax Number”.

You can select a recipient by the following operations:

- Selecting a contact by double-clicking on it**
 Double-click on a contact in the list of the search results. Since [Email] is set as the factory default, only the Email address of the recipient selected by double-clicking on a contact is displayed in “Selected Contacts”. To change the setting of the recipient to be selected upon double-clicking, select [Default Configuration], [Type Selection] in the [View] menu and then one of [Fax], [Email] and [Both].
- Selecting a contact from a shortcut menu**
 Right-click on the contact in the list of the search results, select [Select] from the shortcut menu and then select either [Fax Number] or [Email].
- Removing a recipient**
 Select a recipient in the “Selected Contacts” and click [Remove].

9 Confirm the recipients and click [OK].

The AddressBook Viewer is closed and the recipients selected for “To” are displayed on the list.

Tip

When the fax transmission is completed, the recipients are automatically removed from the “To” list.

■ Removing recipients

You can remove a recipient from the “To” list in the N/W-Fax driver properties.

1 Select a recipient and click [Remove].

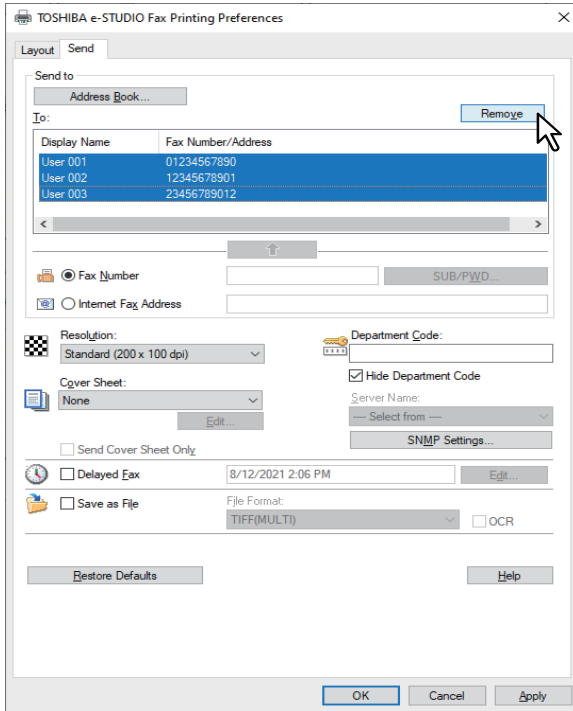

The selected recipient is removed.

Setting up the N/W-Fax Driver

There are two ways to set the N/W-Fax driver options: One is to make the initial settings of the options and the other is to set each option for each individual job.

■ Making the initial settings of the N/W-Fax driver options

Setting the N/W-Fax options by displaying the N/W-Fax driver properties from the Printers folder on the Windows [Start] menu will establish the initial settings of the options.

- 1 Click [Start] and select [Settings] > [Devices] > [Devices and printers].**
- 2 Right-click [TOSHIBA e-STUDIO Fax], and then select [Printing preferences] or [Printer properties] from a shortcut menu.**
If [File] menu is not displayed, press [Alt].

■ Setting print options for each print job

Setting the N/W-Fax driver options by displaying the printer properties from the [Print] dialog box within an application will establish the settings for the current N/W-Fax job. The N/W-Fax driver option settings specific to each N/W-Fax job are set using this method.

- 1 Click the [File] menu and select [Print] on an application.**
- 2 Select [TOSHIBA e-STUDIO Fax] and click [Properties] or [Preferences].**

Setting up the N/W-Fax Driver Options

You can make the settings for the N/W-Fax driver options. For example, you can specify the recipients, resolution, and paper size.

■ Setting up the [Layout] tab

On the [Layout] tab, you can set the size and the orientation of the paper.

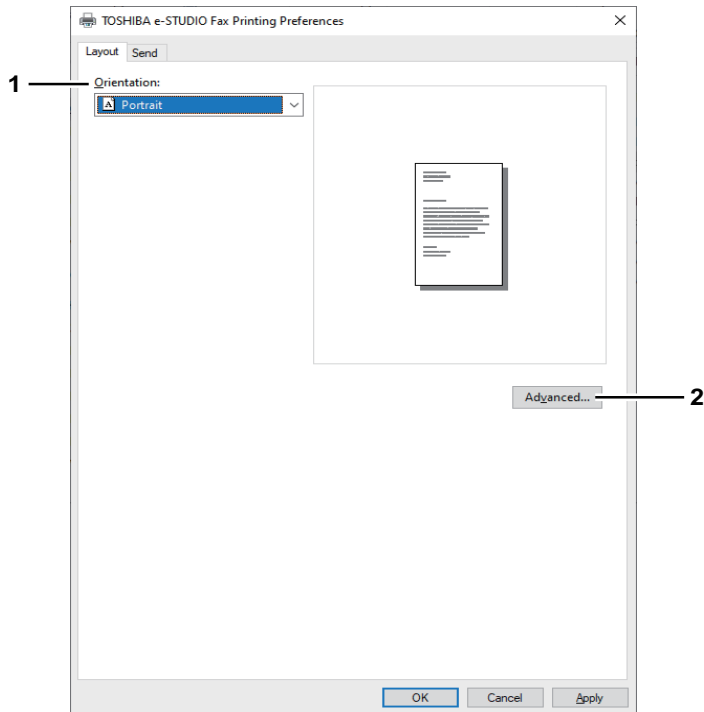

1. Orientation

Set the printing orientation of the document.

- **Portrait** — Data are printed vertically to the paper.
- **Landscape** — Data are printed horizontally to the paper.

2. [Advanced]

Click this to display the [Advanced Option] dialog box. You can select the paper size of the document.

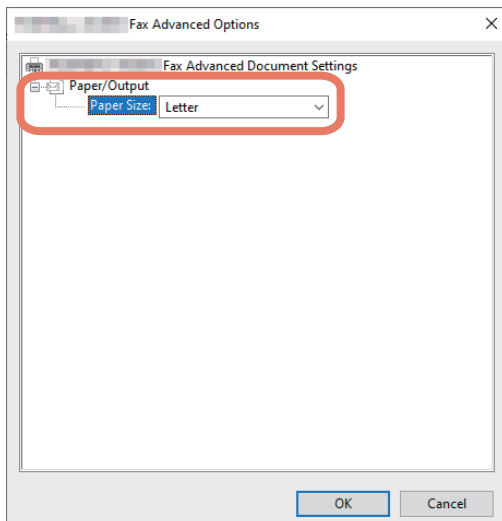

■ Setting up the [Send] tab

In the [Send] tab, you can specify the recipients and how the fax will be sent.

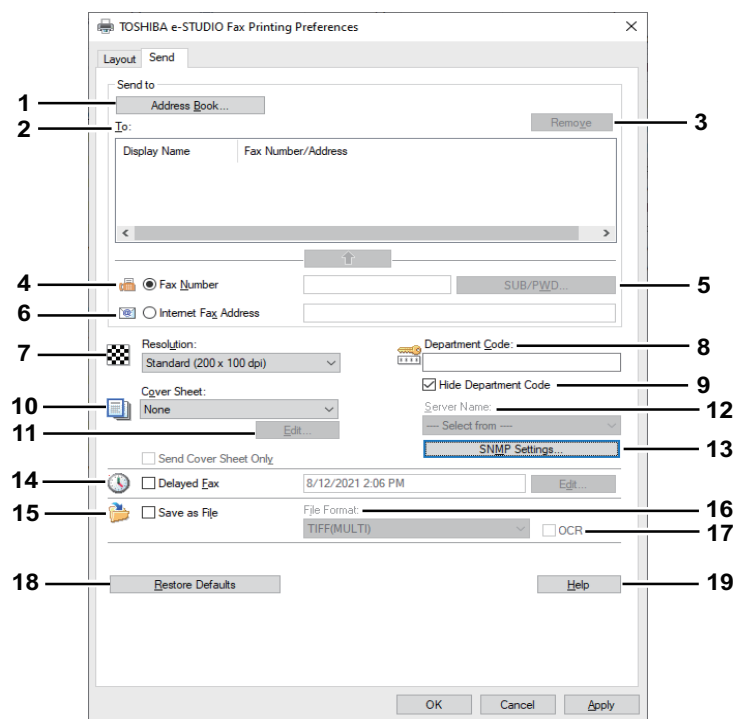

1. [Address Book]

Click to launch the AddressBook Viewer. You can select recipients from the address book.

P.86 “Selecting recipients from the address book”

2. To

This displays the specified recipients list.

P.84 “Specifying Recipients of Network Faxes”

3. [Remove]

Select a recipient in the [To] list and click this to remove the recipient from the list.

P.92 “Removing recipients”

4. Fax Number

Enter the recipient’s fax number directly.

P.84 “Entering recipients from the keyboard”

5. [SUB/PWD]

Click this to display the [SUB/PWD] dialog box. You can add a sub address and a password to the entered fax number.

P.84 “Entering recipients from the keyboard”

6. Internet Fax Address

Enter the recipient’s Internet Fax number directly.

P.84 “Entering recipients from the keyboard”

7. Resolution

Select the resolution for the fax.

- **Standard (200 x 100 dpi)** — Select this to send a document in Standard mode (200 x 100 dpi).
- **Fine (200 x 200 dpi)** — Select this to send a document in Fine mode (200 x 200 dpi).
- **Super Fine (200 x 400 dpi)** — Select this to send a document in Super Fine mode (200 x 400 dpi).
- **Ultra Fine (400 x 400 dpi)** — Select this to send a document in Ultra Fine mode (400 x 400 dpi).

8. Department Code

Enter a department code of 1 to 63 characters if required. When the department code is enabled on the MFP, you must enter it to send a fax.

Note

- If you do not enter a department code when it is enabled on the MFP the [Invalid Department Code Print Job] is set to “Store to invalid job list” in TopAccess, the job will be stored in the Invalid job list without being transmitted. You can print or delete a stored job from the [Job Status] on the touch panel.
- If you do not enter the department code when the department code is enabled on the MFP and the [Invalid Department Code Print Job] is set to PRINT in TopAccess, the job will be sent.
- If you do not enter the department code when the department code is enabled on the MFP and the [Invalid Department Code Print Job] is set to DELETE in TopAccess, the job will be deleted automatically.

9. Hide Department Code

Select this check box to display a department code in the hidden symbols.

10. Cover Sheet

Select a cover sheet type among [Standard Cover Page], [Business Cover Page], [Professional Cover Page] and [My Cover Page] if you want to attach a cover sheet to the first page of the document.

 P.106 “Sending with a cover sheet”

11. [Edit]

Click this to display the [Cover Sheet Settings] dialog box. You can perform various kinds of editing on the cover sheet selected in the Cover Sheet setting, such as entering a subject or a message, or changing the type or size of the fonts.

 P.97 “Setting up the Cover Sheet”

12. Send Cover Sheet Only

Select this check box to send a cover sheet only.

13. Server Name

Select the desired LDAP server in the [Server Name] box if needed.

Tip

You can make settings for the LDAP server on the [Device Settings] tab.

 P.100 “Setting up the [Device Settings] tab”

14. [SNMP Settings]

Click this to check or change the SNMP settings.

 P.98 “Setting up the SNMP”

15. Delayed Fax

Select this to send a document at a specified date and time. When this is selected, click [Edit] to display the [Scheduled Time] dialog box and specify date and time the job will be transmitted. The job sent to the MFP will be stored in the Fax queue until the specified date and time.

 P.105 “Delayed transmission reservation”

16. Save as File

Select this to save documents in the “file_share” folder in the MFP as well as send the document as a fax and Internet Fax.

 P.104 “Saving a fax as a file”

Tip

- When the cover sheet is set, the cover sheet and the original will be stored in the “file_share” folder.
- The maximum capacity in the shared folder differs depending on your model or operating environment. The total available space in the shared folder and e-Filing can be checked on the [Device] in TopAccess.

17. File Format

Select the file format of the document that will be saved. This option can be selected only when the [Save as File] check box is selected.

18. OCR

Select this check box to enable the OCR function. This option can be selected only when the [Save as File] check box is selected.

19. [Restore Defaults]

Click this to restore the settings to make the equipment as it was at the time of factory shipment.

20. **[Help]**
Click this to browse Help for the N/W-Fax driver.

■ Setting up the Cover Sheet

You can set the content of the cover sheet to be attached to a fax.
 P.106 “Sending with a cover sheet”

Note

Emoji is not available for a cover sheet.

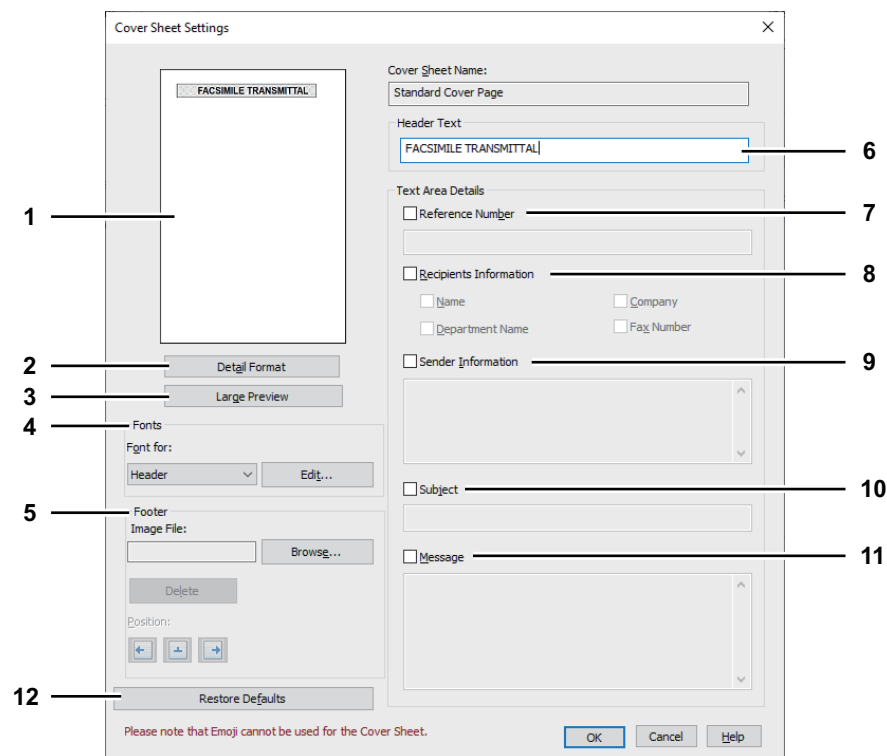

1. **Preview**

The image of the cover sheet can be previewed. You can check the layout of the character strings and images.

Note

- Depending on the line feed positions, the preview may not duplicate the actual print result of the cover sheet, but is used for checking its layout.
- If the contents are on more than one page, such as the many line feeds included in “Sender Information” or “Message”, only the first one page is displayed in the preview.

2. **[Simple Format]/[Detail Format] switch button**

Switch the display format for the description of the sending information on the cover sheet. By selecting [Detail Format], ruled lines appear. By selecting [Simple Format], no ruled lines appear. [Simple Format] is set as the default. [Detail Format] is displayed on the button.

3. **[Large Preview]**

Click this to display the cover sheet on another screen. You can enlarge the preview or display another page when there are multiple pages.

4. **Fonts**

Select the font to be used for the cover sheet. Select the section for which the font is used, and then click [Edit] to select the type, style and size of the font.

- **Header** — Set the font to be used for the header of the cover sheet.
- **Title** — Set the font to be used for the title such as Reference Number, Recipients Information, Sender Information, Subject or Message.
- **Body** — Set the font to be used for the body of each title.

5. Footer

Select an image file to be attached to the footer of the cover sheet.

- **[Browse]** — Click this to select an image file to be attached to the footer within 1 MB.
- **[Delete]** — Click this to delete the attached image file.
- **Position** — Select the position of the image file from the left, center and right.

6. Header Text

Enter a title to be displayed on the header of the cover sheet; it can be up to 63 characters.

7. Reference Number

Check this to have a reference number identifying the fax to appear on the cover sheet. Enter the reference number in the text box.

8. Recipient's Information

Check this to have the recipient's information appear on the cover sheet. Select the desired information among the options below.

- **Name** — Check this to have the recipient name appear on the cover sheet.
- **Company** — Check this to have the recipient company name appear on the cover sheet.
- **Department Name** — Check this to have the recipient department name appear on the cover sheet.
- **Fax Number** — Check this to have the recipient fax number or Email address appear on the cover sheet.

9. Sender Information

Check this to have the sender's information appear on the cover sheet. You can enter the information in up to 500 characters.

10. Subject

Check this to have a subject appear on the cover sheet. You can enter the subject in up to 40 characters.

11. Message

Check this to have a message appear on the cover sheet. You can enter the message in up to 500 characters.

12. [Restore Defaults]

Click this to restore the settings to make the equipment as it was at the time of factory shipment.

■ Setting up the SNMP

If the recipient's MFP is not found over the Internet and the fax job is not sent normally, the SNMP settings may be the cause. Check that the SNMP settings are correct in the [SNMP Settings] dialog box, and if not, change them.

Note

Ask the administrator for details on the SNMP Network settings configured for your MFP.

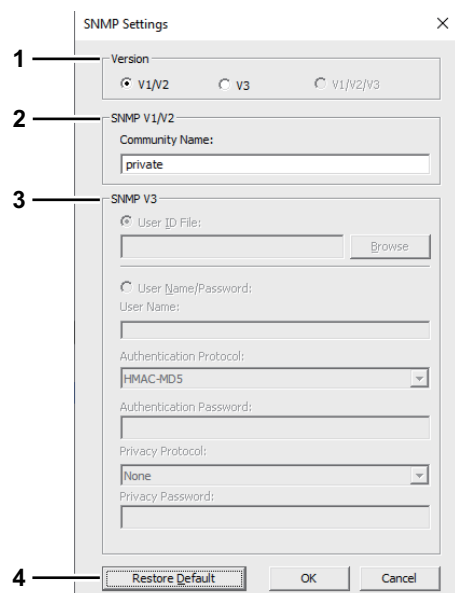

1. Version

Be sure to have the correct SNMP version set for your MFP and select from the following options:

- **V1/V2** — Select this option to enable SNMP V1 and V2.
- **V3** — Select this option to enable SNMP V3.
- **V1/V2/V3 (for [Discovery Settings] dialog box only)** — Select this option to enable SNMP V1, V2, and V3.

2. SNMP V1/V2

Community Name — If a community name other than “private” (default) is set for the SNMP community name for your MFP, enter its community name.

Note

- To send fax jobs normally under an SNMP V1/V2 environment, the SNMP community names must be the same in the 3 settings shown below. For details, ask your administrator.
 - Your MFP
 - [SNMP Settings] dialog box of the [Send] tab

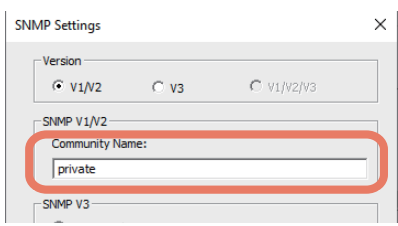

- [Port Settings] tab in the N/W-Fax driver

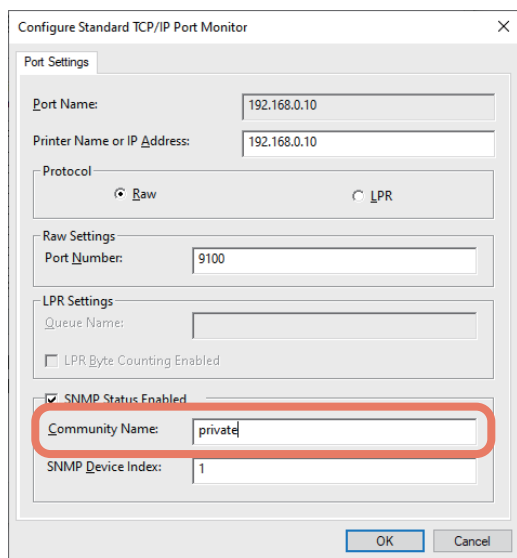

- To change the community name, the administrator privilege is necessary. You must log in with the “Administrator” privilege and open the printer driver properties.
- Up to 31 characters including the following symbols can be entered for the Community Name.
! " # \$ % & ' () * + , - / : ; < = > ? @ [\] ^ _ ` { | } ~

3. SNMP V3

If SNMP V3 is enabled, select one of the following items to set how users are authenticated.

User ID File — Select this option when you want to use a user ID file. Click [Browse] and specify the user ID file.

User Name/Password — Select this option when you want to use the user name and password. When this option is selected, enter or select the following items:

- **User Name**
- **Authentication Protocol**
- **Authentication Password**
- **Privacy Protocol**
- **Privacy Password**

Note

- If you select to enable SNMP V3, consult your network administrator for preliminary advice on how to authenticate users.
- Up to 31 characters including the following symbols can be entered for each of the User Name, Authentication Password and Privacy Password.
! \$ % & ' () - , < > @ [] ^ _ ` { } ~
- This function is not available when your computer and MFP are connected with a USB cable.

4. [Restore Default]

Click this to restore the settings to make the equipment as it was at the time of factory shipment.

■ Setting up the [Device Settings] tab

On the [Device Settings] tab, you can change a setting for N/W-Fax driver update or display the software version of the driver.

Note

Ask the administrator for details on the settings configured for your MFP.

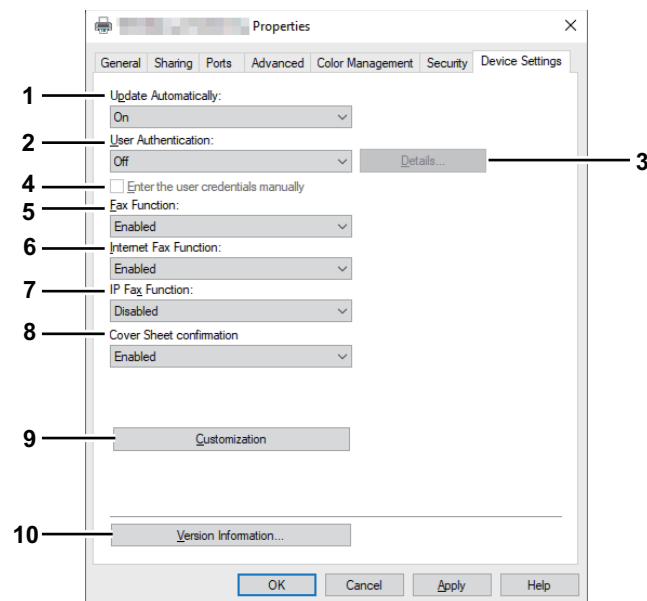

1. Update Automatically

Select whether or not the setting information of each item on the [Device Settings] tab of the N/W-Fax driver is to be obtained by automatically communicating with your MFP every time this tab is opened.

- **On** — Select this to obtain the setting information automatically.
- **Off** — Select this not to obtain the setting information automatically. Set each item manually.

Note

This function is not available when your computer and MFP are connected with a USB cable.

2. User Authentication

Select the authentication method which is to be used. Set it to correspond to that of your MFP.

- **Off** — Select this not to perform user authentication.
- **MFP Local Authentication** — Select this to perform MFP Local Authentication.
- **Windows Domain Authentication** — Select this to perform Windows Domain Authentication.
- **LDAP Authentication** — Select this to perform LDAP Authentication.

Tip

If the user authentication and project code are enabled in the equipment, you need to enter the project code when sending the fax.

3. [Details]

The [LDAP Server Settings] dialog box will appear. This option can be selected only when [LDAP Authentication] is selected in the [User Authentication] box.

 P.103 “Setting up LDAP servers”

4. Enter the user credentials manually

When this check box is selected, you are prompted to enter your user name and password every time you send a fax. This option is available when any of MFP Local Authentication, Windows Domain Authentication, or LDAP Authentication is selected in the [User Authentication] box.

Tip

- To configure this option, select [Off] in the [Update Automatically] box.
- This option can be used together with any of the user authentication functions (MFP Local Authentication, Windows Domain Authentication, LDAP Authentication).

5. Fax Function

Select whether or not the fax function is enabled. Set it to correspond to that of your MFP.

- **Enabled** — Select this to enable the fax function.
- **Disabled** — Select this to disable the fax function.

6. Internet Fax Function

Select whether or not the Internet Fax function is enabled. Set it to correspond to that of your MFP.

- **Enabled** — Select this to enable the Internet Fax function.
- **Disabled** — Select this to disable the Internet Fax function.

7. IP Fax Function

Select whether or not the IP Fax function is enabled. Set it to correspond to that of your MFP.

- **Enabled** — Select this to enable the IP Fax function.
- **Disabled** — Select this to disable the IP Fax function.

8. Cover Sheet confirmation

Select whether or not to display a message indicating a precaution that a cover sheet is being selected when a fax job is sent.

- **Enable** — Select this to display the message.
- **Disable** — Select this not to display the message.

9. Customization

The [Customization] dialog box is displayed.

 P.102 “Customization: [Language] tab”

10. [Version Information]

Click this to display the software version information of the N/W-Fax driver.

■ Customization: [Language] tab

You can switch N/W-Fax driver language.

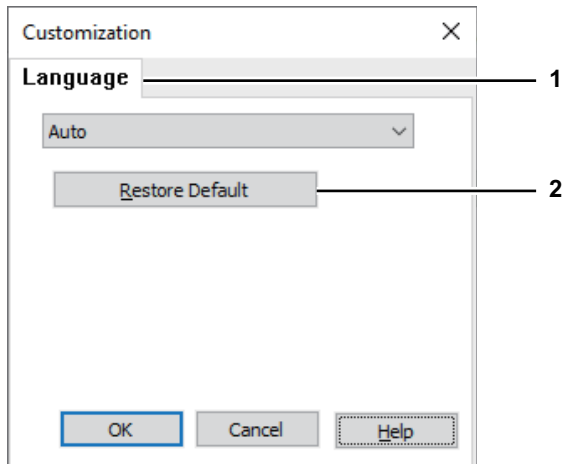

1. Language

This selects the language to be used.

- **Auto** / Chinese (Simplified, China) / Danish (Denmark) / Dutch (Netherlands) / English (United States) / Finnish (Finland) / German (Germany) / Italian (Italy) / Spanish (Spain, Traditional Sort) / French (France) / Norwegian Bokmål (Norway) / Russian (Russia) / Chinese (Traditional, Taiwan) / Turkish (Turkiye) / Japanese (Japan) / Polish (Poland) / Swedish (Sweden) / Portuguese (Brazil)

Tip

[Auto] is selected by default. When [Auto] is selected, the most appropriate printer driver language is automatically set according to the regional and language settings in Windows OS.

2. [Restore Defaults]

Click this to restore the factory defaults on the [Language] tab.

■ Setting up LDAP servers

The [LDAP Server Settings] dialog box allows you to register LDAP servers.

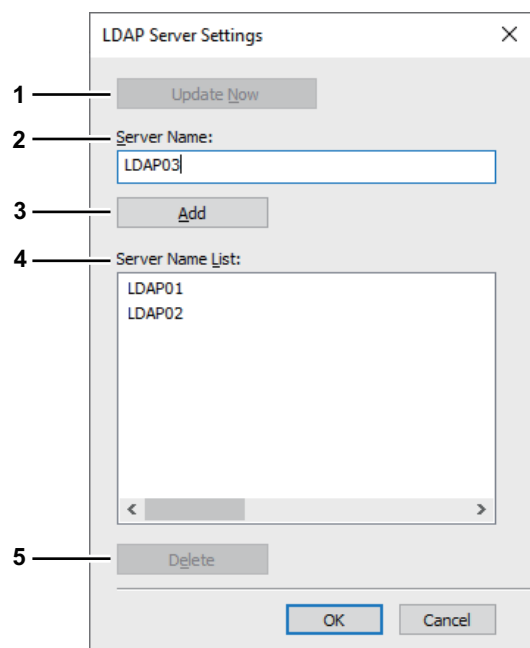

- 1. [Update Now]**
Click this to obtain LDAP server information automatically from your MFP, and register it in [Server Name List].

Note

This function is not available when your computer and MFP are connected with a USB cable.

- 2. Server Name**
Enter the desired LDAP server in this box if needed.

Tip

Up to 64 characters (excluding # ; \ =) can be entered for the [Server Name] box.

- 3. [Add]**
Click this button to register the LDAP server in the [Server Name List], which has been entered in the [Server Name] box.

- 4. Server Name List**
The registered LDAP servers are displayed in this list. Up to 16 LDAP servers can be registered.

- 5. [Delete]**
Click this button to delete an LDAP server in [Server Name List]. Select the LDAP server that you want to delete in the list, and click this button.

Sending With Extended Fax Functionality

The N/W-Fax driver allows users to perform the following features.

■ Saving a fax as a file

You can save a document in the “TXFAX” folder in the “file_share” folder in the MFP as well as sending the document to fax numbers and Email addresses.

1 Display the [Send] tab and select the [Save as File] check box.

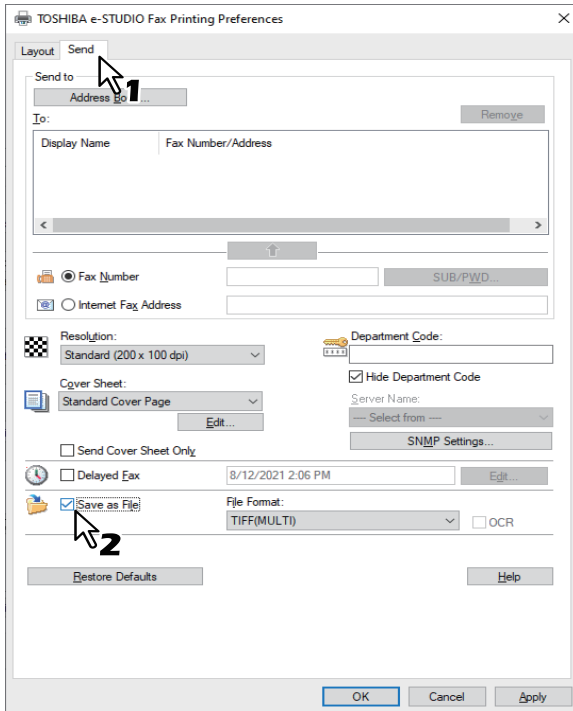

2 Select the file format in the [File Format] box.

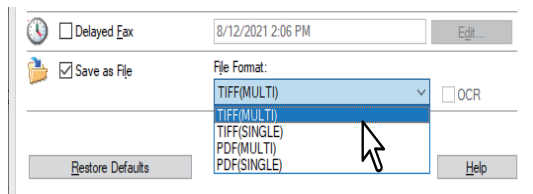

3 Specify the other options to send a document and click [OK].

4 Click [OK] (or [Print]) to send a document to the MFP.

The document is saved in the “TXFAX” folder in the “file_share” folder in the MFP.

Tip

- The saved file contains the cover sheet when the cover sheet is set.
- Since the image smoothing function does not work for the image stored in the “file_share” folder, its printing image quality differs from the normal fax image quality.

■ Delayed transmission reservation

When the delayed transmission is specified, the fax is stored in the fax queue in the MFP and will be sent at the specified date and time.

1 Display the [Send] tab and select the [Delayed Fax] check box.

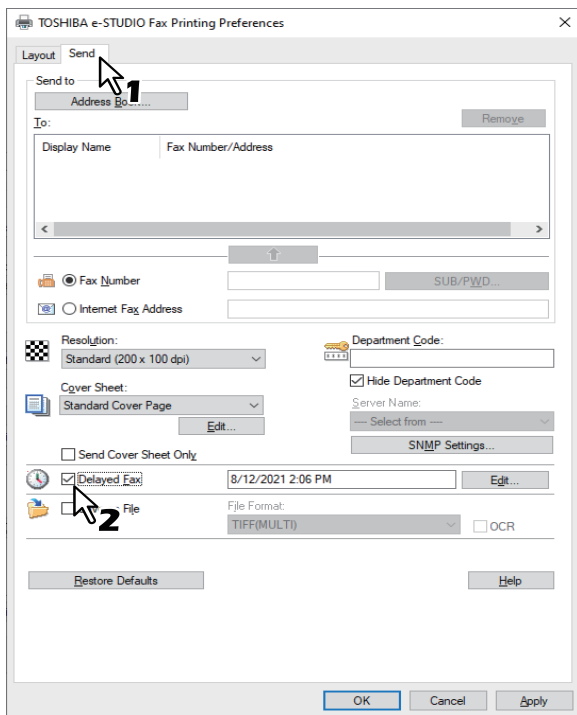

2 Click [Edit].

The [Scheduled Time] dialog box appears.

3 Select the date and time and click [OK].

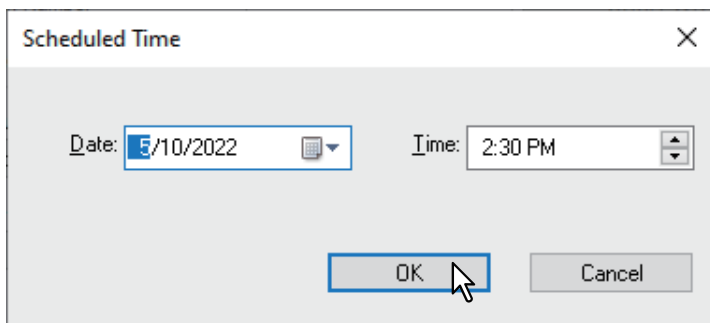

- You can click the arrow in the Date box to display a calendar that allows you to select a date.
- Enter the time to start the fax transmission. You can use the up and down arrows.

4 Specify the other options to send a document and click [OK].

5 Click [OK] (or [Print]) to send a document to this equipment.

■ Sending with a cover sheet

You can choose to send a cover sheet with your fax transmission. You can select what to include on the cover sheet such as sender or recipient information.

Note

- When a printer driver whose name consists of 54 letters or more is specified for the default printer and an attempt is made to send a fax with a cover sheet added from Microsoft Excel using a N/W-Fax driver with an IPP port, an XL error may occur and fax transmission may be impossible. (This error does not occur in application software other than Microsoft Excel.)
If this error occurs, perform one of the following and start sending a fax again.
 - Use 30 letters or less for the N/W Fax driver name.
 - Do not attach any cover sheet.
- Emoji is not available for a cover sheet.

1 Display the [Send] tab, select the cover sheet type in the [Cover Sheet] box and then click [Edit].

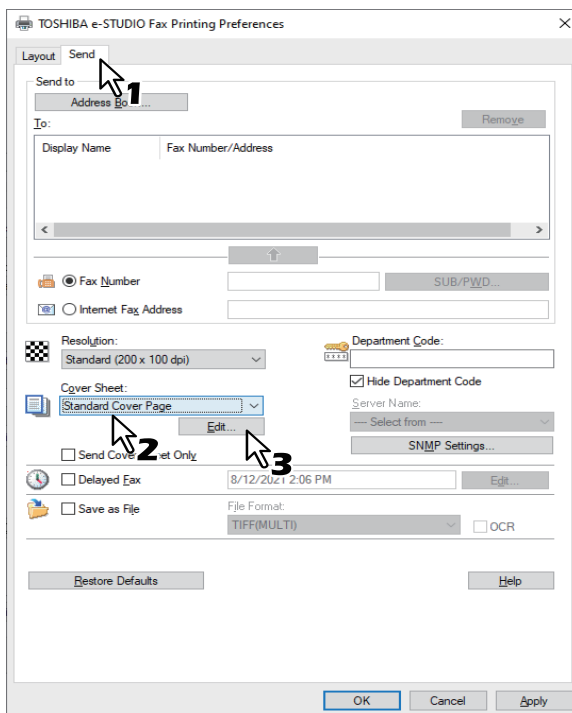

The [Cover Sheet Settings] dialog box appears.

2 Enter the title of the cover sheet in the [Header Text] box.

The screenshot shows the 'Cover Sheet Settings' dialog box. On the left is a preview of the cover sheet with 'FACSIMILE TRANSMITTAL' at the top. The main area has 'Cover Sheet Name' set to 'Standard Cover Page'. The 'Header Text' field is highlighted with a red box and contains 'FACSIMILE TRANSMITTAL'. Below it, the 'Text Area Details' section has several unchecked checkboxes: 'Reference Number', 'Recipients Information', 'Sender Information', 'Subject', and 'Message'. The 'Recipients Information' section includes checkboxes for 'Name', 'Company', 'Department Name', and 'Fax Number'. At the bottom are 'OK', 'Cancel', and 'Help' buttons. A note at the bottom left states: 'Please note that Emoji cannot be used for the Cover Sheet.'

You can enter up to 63 characters for the header text.

3 If you want a reference number identifying the document to appear on the cover sheet, select the [Reference Number] check box and then enter the reference number in the text box.

This screenshot shows the 'Cover Sheet Settings' dialog box with the 'Reference Number' checkbox checked and highlighted with a red box. The text box below it contains '000000001'. The 'Header Text' field still contains 'FACSIMILE TRANSMITTAL'. The 'Recipients Information' section remains unchecked.

You can enter up to 20 characters for the reference number.

4 If you want the recipient's information to appear on the cover sheet, select the [Recipient Information] check box and then select the options required for the recipient information.

This screenshot shows the 'Cover Sheet Settings' dialog box with the 'Recipients Information' checkbox checked and highlighted with a red box. The sub-options 'Name', 'Company', 'Department Name', and 'Fax Number' are also checked. The 'Reference Number' checkbox remains checked, and the text box below it contains '000000001'. The 'Header Text' field still contains 'FACSIMILE TRANSMITTAL'.

Name — Check this to have the name of the recipient appear on the cover sheet.

Company — Check this to have the company name of the recipient appear on the cover sheet.

Department Name — Check this to have the department name of the recipient appear on the cover sheet.

Fax Number — Check this to have the fax number or Email address of the recipient appear on the cover sheet.

Note

- Recipient information is obtained from the address book. If the recipient is added manually, this information does not appear on the cover sheet except for the fax number or Email address.
- The recipient information for all recipients will appear on the cover sheet.

5 If you want sender information to appear on the cover sheet, select the [Sender Information] check box and then enter the sender information in the text box.

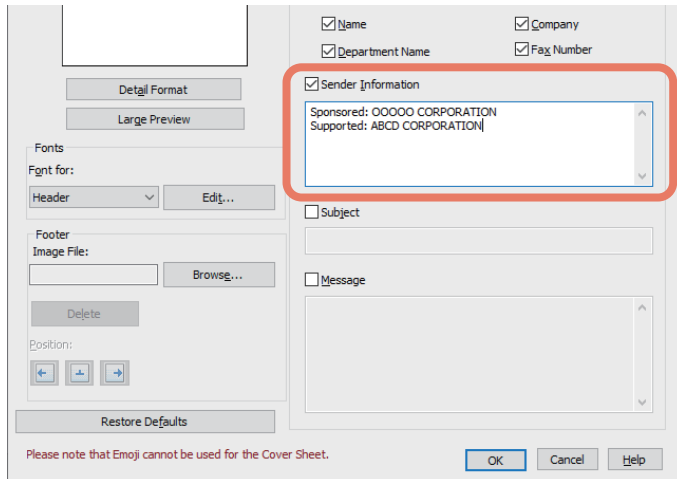

The screenshot shows a software window with various settings. On the right side, there are several checkboxes: 'Name', 'Company', 'Department Name', 'Fax Number', and 'Sender Information'. The 'Sender Information' checkbox is checked and highlighted with a red box. Below it is a text box containing the text: 'Sponsored: OOOOO CORPORATION' and 'Supported: ABCD CORPORATION'. Other checkboxes like 'Subject' and 'Message' are unchecked. The interface also includes sections for 'Fonts', 'Footer', and 'Position'.

You can enter up to 500 characters for the sender information.

6 If you want a subject to appear on the cover sheet, select the [Subject] check box and then enter the subject in the text box.

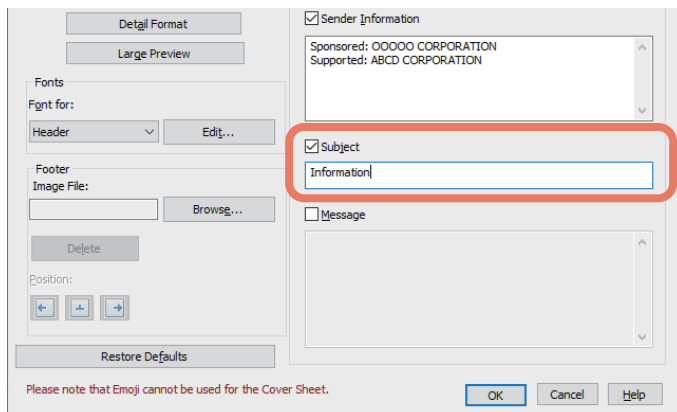

The screenshot shows the same software window as in step 5. The 'Sender Information' checkbox is still checked. The 'Subject' checkbox is now checked and highlighted with a red box. Below it is a text box containing the text: 'Information'. The 'Message' checkbox remains unchecked.

You can enter up to 40 characters for the subject.

7 If you want a message to appear on the cover sheet, select the [Message] check box and then enter the message in the text box.

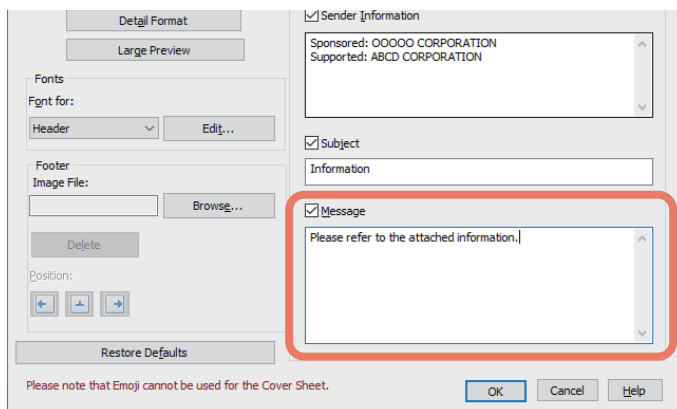

The screenshot shows the same software window. The 'Subject' checkbox is still checked. The 'Message' checkbox is now checked and highlighted with a red box. Below it is a text box containing the text: 'Please refer to the attached information.'. The 'Sender Information' checkbox remains checked.

You can enter up to 500 characters for the message.

8 If you want to change the font of the characters on the cover sheet, select the corresponding section in the [Font for] box, and then click [Edit].

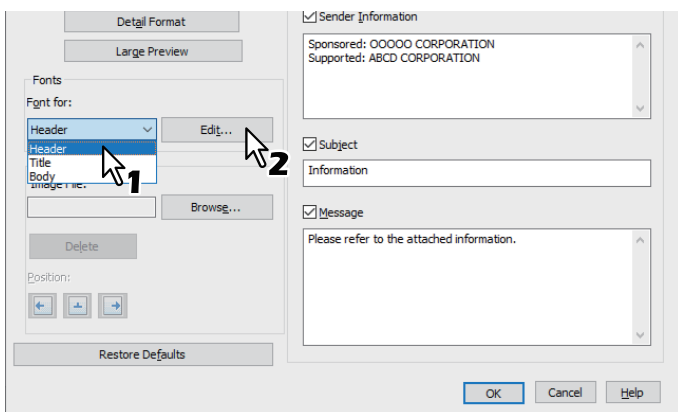

The [Font] dialog box appears.

If you do not change the font, proceed to step 10.

9 Select the desired one from each of the [Font], [Font style], [Size] and [Script] boxes, and then click [OK].

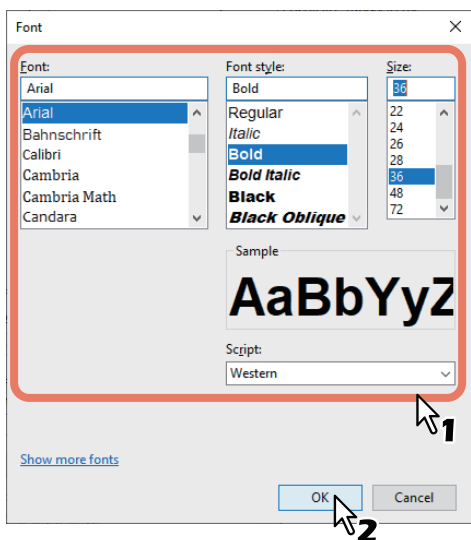

The [Font] dialog box is closed and the font settings are determined for the selected section.

Tip

If you want to change the font of other sections, repeat the procedure from step 8.

10 If you want to attach an image file on the footer, click [Browse] of Image File.

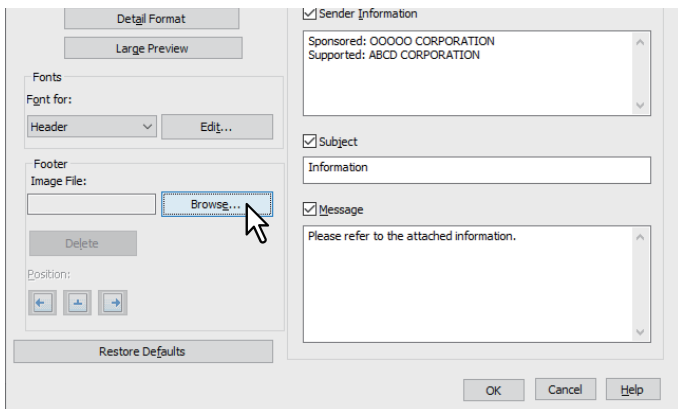

The [Open] dialog box appears.

If you do not attach an image file, proceed to step 13.

11 Select an image file to be attached and then click [Open].

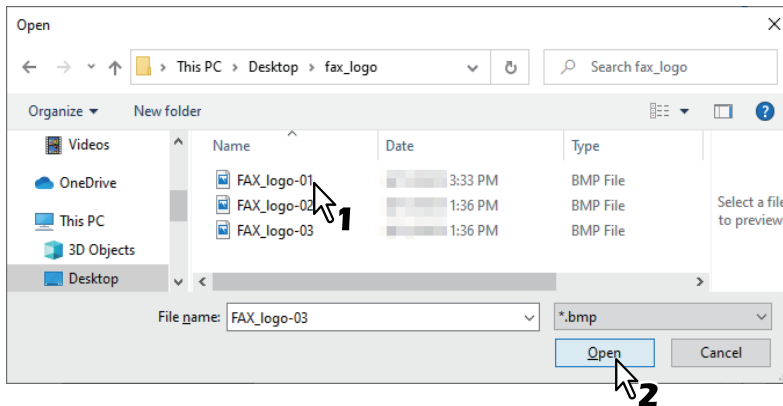





The [Open] dialog box is closed and the selected image file is attached.

Note

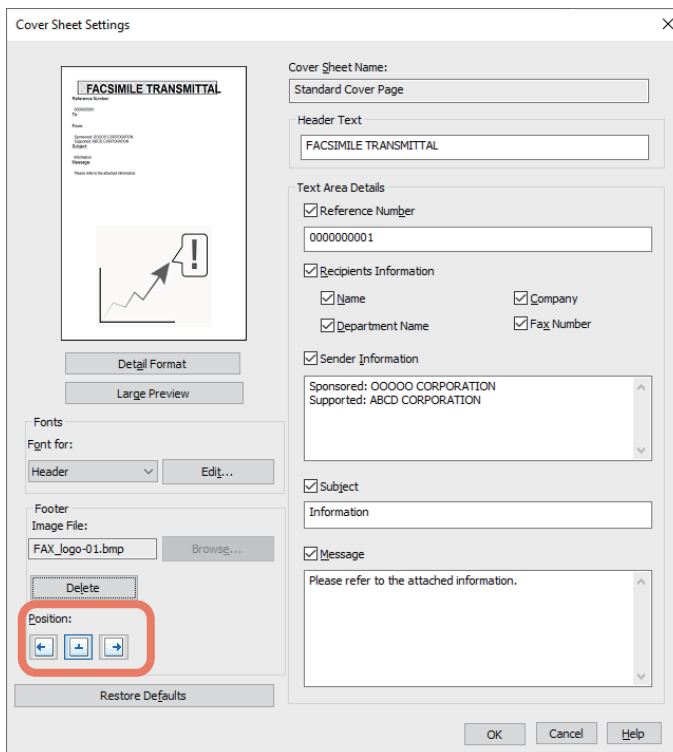
Attach the image file in a bitmap format (.bmp) within 1 MB.

12 Select the position of the image file.



- : Select this to align the image to the left.
- : Select this to align the image to the center.
- : Select this to align the image to the right.

13 Specify the other options to send a document and click [OK].

14 Click [Print] to send a document to the MFP.

USING THE INTERNET FAX

Internet Fax Features	112
Precautions for Internet Fax Transmissions.....	113
Sending Internet Faxes	114
Sending Internet faxes.....	114
Setting advanced functions	115
Saving data sent in a file along with internet fax transmission.....	115
Receiving Internet Faxes.....	116
Available file formats	116
Receiving Internet faxes	116

Internet Fax Features

Internet Fax allows a copy of a scanned document to be sent as an E-mail with an attached TIFF-FX (Profile S) file. Since an Internet line is used instead of a phone line, the communication costs can be dramatically reduced. With Internet Fax, an E-mail address is to be specified in place of a phone number to transmit a copy of a scanned document to the Internet Fax equipment or the client computers. When an Internet Fax is received, it is automatically output just like a traditional fax.

Note

Internet faxing requires the network settings configured by the network administrator. Consult your network administrator for help.

With Internet Fax, you can perform various transmissions as illustrated below.

• Internet Fax Equipment to Internet Fax Equipment

The equipment can send a copy of a document to other Internet Fax equipment via Internet or Intranet. The copy of the document is sent as an E-mail.

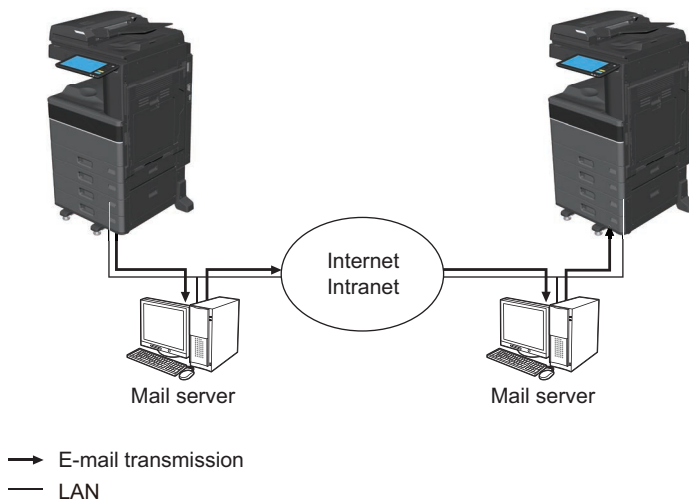

• Internet Fax Machine to/from Client Computers

The equipment can send a copy of a document as an E-mail to client computers via Internet or Intranet. The client computers can send an E-mail to the equipment as well.

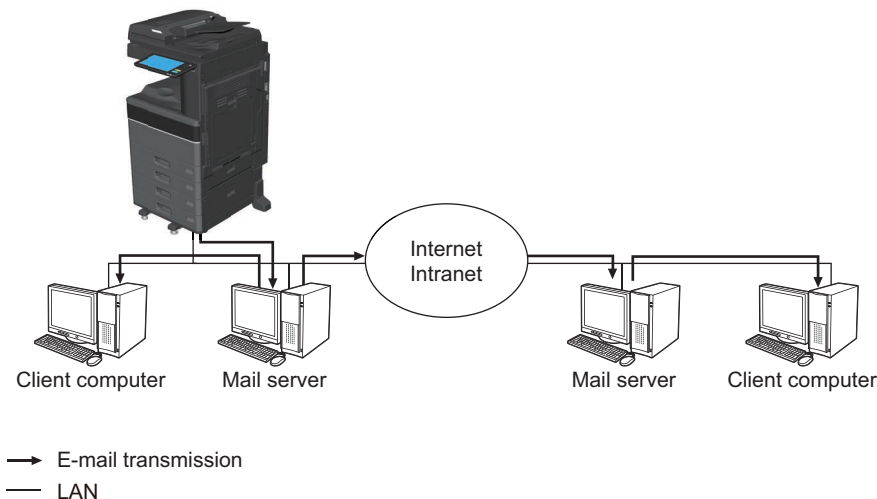

Note

- When the equipment sends a copy of a document using Internet Fax, the client computer receives the copy as TIFF-FX (Profile S) images.
- The MFP can print out only text files and image files in TIFF format; from the client computer, you cannot send files other than text or TIFF images to the MFP. For available formats, see the reference below:
📖 P.116 “Available file formats”

Precautions for Internet Fax Transmissions

Internet Fax works just like e-mail and may cause the same kinds of troubles as E-mail unless you understand how it works. Before you start using the Internet Fax feature, carefully read and familiarize yourself with the following precautions:

- Internet Fax sends a copy of a document to your E-mail server, not via the PSTN* as with a traditional fax. The data is then sent from the server to the Internet. Unlike traditional faxing, Internet faxing does not involve a direct communication with the recipient(s). Transmission is considered complete when the sent copy of the document reaches your E-mail server.
- The security level of Internet transmissions is low. We recommend traditional faxing when sending confidential documents.
- Due to heavy line traffic, Internet transmissions may take a while to arrive.
- The configuration of the E-mail server may prevent successful transmission if the data size of the sent document exceeds set limits.
- When you send an Internet fax to multiple recipients, all the recipients' E-mail addresses are printed if the header page is set to be printed on the recipients devices. If you need to secure the personal information, send the Internet fax separately to each recipient rather than sending to multiple recipients at the same time.

* PSTN (Public Switched Telephone Network) is a global telephone system capable of communicating worldwide using copper wires to transmit analog data.

Sending Internet Faxes

Just like the Scan to E-mail function, Internet Fax sends scanned data to specified E-mail addresses as an attached file. The difference is the format of the file; it is TIFF-FX (Profile S), which can be received and printed on Internet Fax devices. With a few additional steps, you can also save the sent data or set advanced functions for each transmission.

Note

To use the Internet Fax feature, the network administrator must set the equipment configuration.

■ Sending Internet faxes

1 Place the original(s).

 P.14 “Placing an original”

2 Press [Fax] on the Home screen.

3 Set the transmission conditions.

• Original Size

Press the corresponding button for the original size. To have the equipment automatically set the original size, press [Auto].

When using originals of various paper widths, press [Different Width].

 P.22 “Setting the original size”

• Resolution



Select the resolution for scanning the original.

 P.23 “Setting the resolution”

For the setting items related to the internet fax which should be set as other transmission conditions, see the reference below:

 P.24 “Setting other transmission conditions”

• Exposure

Select the appropriate exposure for scanning the original. Pressing [Auto] automatically sets the exposure best suited to your originals. To set the exposure manually, use  or  to select the appropriate exposure.

• Original Mode

Select an original mode to scan the original for the best image quality.

- [Text/Photo] — Press this button to scan an original consisting of both text and photos.

- [Text] — Press this button to scan an original consisting of text.

- [Photo] — Press this button to scan an original containing photo images printed on photographic paper.

• 2-Sided Scan

Select the type (1-sided or 2-sided) of the original to be scanned

Single: Press this button to scan a 1-sided original.

Book: Press this button to scan a 2-sided right-to-left (book-type) original.

Tablet: Press this button to scan a 2-sided top-to-bottom (tablet-type) original.

• Tx Type

When sending an Internet Fax, you can only select [Memory Tx].

 P.24 “Setting other transmission conditions”

• [Subject]

Enter the subject of the Internet Fax to be sent.

• [Body]

Enter the body message of the Internet Fax to be sent.

Note

- All the settings required for Internet faxing are mentioned in the above steps. Settings other than the above apply only to fax transmissions.
- When sending an Internet Fax, [Fine] is always applied even if you select [U-Fine] in Resolution.
- Internet faxing sends copies of A4, LT or LG size originals in the same size as the originals'. Originals larger than A4, LT, or LG are reduced to A4 or LT, whereas originals smaller than these sizes are sent as A4 or LT without being enlarged.

Tip

- When either [Text/Photo] or [Photo] is selected in Original Mode, the transmission may take a while.
- The administrator can change the body message from TopAccess. For details, see the reference below:
TopAccess - [Administration] - [Setup] Item List - InternetFax settings - Setting up InternetFax Setting

4 Specify the E-mail address of the recipient.

 P.27 “Specifying the recipient”

Tip

You can save the sent data as a file.

 P.114 “Sending Internet Faxes”

5 Press [Send].

 P.19 “Sending a Fax”

Setting advanced functions

The following advanced functions can be set during an Internet faxing operation. The setting method for these functions is the same as that for those of the general fax sending operation. For details, see the reference below:

- **Priority Reserve** — Use this function when you want to send originals ahead of the currently reserved transmissions.

 P.51 “Communicating to a Request from a Recipient (Polling Communication)”

Saving data sent in a file along with internet fax transmission

When sending an Internet fax, you can also save the sent data in the equipment’s shared folder and/or a network folder (Remote 1 or 2).

Note

- To save the data in a network folder, the administrator needs to set the equipment configuration. For details, see the reference below:
TopAccess - [Administration] - [Setup] Item List - Save as file settings - Setting up Destination
- Internet Fax and File is not available when the forced encryption setting is enabled. To learn more about the forced encryption setting, see the reference below:

User Functions - SETTING ITEMS (Admin) - Security - Setting secure PDF

Receiving Internet Faxes

■ Available file formats

The equipment can print out TIFF-FX images, TIFF images scanned in black and white, and text data (E-mail messages in the plain text format). In addition, the resolution of the TIFF-FX images must be either 8 x 3.85 or 8 x 7.7 or 8 x 15.4 (dot/mm) while that of scanned TIFF images must be 200 x 100, 200 x 200, 200 x 400, 400 x 400, or 600 x 600 (dpi).

If any files failing to meet the above conditions are attached to a received Internet Fax, an E-mail printing error occurs and is recorded as an error code on the Receive log. On TopAccess, the “Email Print” settings are available for the administrator so that error codes can be printed as a report. The administrator can also set the equipment to forward such Internet Faxes to another E-mail address. For details, see the references below:

TopAccess - [Administration] - [Setup] Item List - InternetFax settings - Report Setting

TopAccess - [Administration] - [Registration] ([Administration]) Item List - Fax Received Forward and InternetFAX Received Forward settings

■ Receiving Internet faxes

The equipment accesses the E-mail server at specified intervals to check whether any E-mail has been delivered. New E-mail is automatically received and printed out unless you check manually.

Tip

Internet Fax reception settings can be changed from TopAccess.

For details, see the reference below:

TopAccess - [Administration] - [Setup] Item List - InternetFax settings - Setting up InternetFax Setting

□ Receiving Internet Faxes automatically

The administrator can set up the equipment configuration on TopAccess to automatically receive Internet faxes from the E-mail server. If the “Scan Rate” setting is specified, the equipment accesses the E-mail server to check for any new E-mail at specified intervals. (The factory default is 5 minutes.) For details, see the reference below:

TopAccess - [Administration] - [Setup] Item List - Network settings - Setting up POP3 Client

□ Receiving Internet Faxes manually

- 1 Press [User Functions -User-] on the Home screen.
- 2 On the [User] tab, press [Check E-mail].

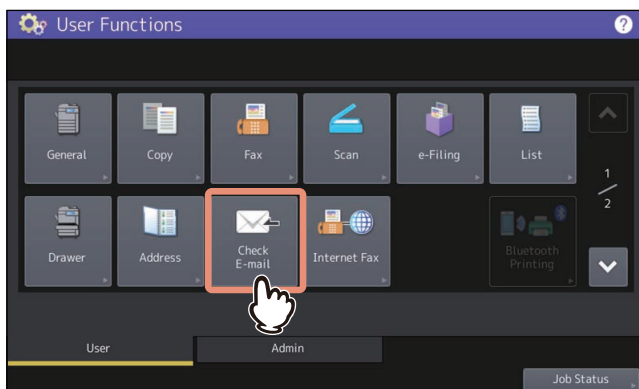

- The equipment begins checking for new E-mail. If Internet Faxes have been received, “RECEIVING E-mail” appears on the screen. After “NEW E-mail RECEIVED” is displayed, the equipment starts printing the Internet Faxes.
- If no new E-mail are found, “CURRENTLY NO E-mail” is displayed on the screen.

PRINTING LISTS AND REPORTS

TRANSMISSION JOURNAL.....	118
RECEPTION JOURNAL	120
RESERVATION LIST	122
MAILBOX/RELAY BOX REPORT.....	123
MEMORY TRANSMISSION REPORT	124
TRANSMISSION REPORT.....	125
MULTI TRANSMISSION REPORT.....	126
MULTI POLLING REPORT	127
RELAY TX ORIG. TERMINAL REPORT.....	128
RELAY TX RELAY STATION REPORT	129
RELAY TX END TERMINAL REPORT	130
RELAY STATION REPORT	131
MAILBOX RECEPTION REPORT	132

TRANSMISSION JOURNAL

Item name	Description
ROM version	Firmware version of the FAX Unit and the MFP. This appears at the upper right of the list.
TIME	Date and time of the output of the journal
FAX NO.1	Sender's fax number (line 1)
FAX NO.2 ^{*1}	Sender's fax number (line 2)
NAME	Registered terminal ID (line 1)
NAME (LINE2)	Registered terminal ID (line 2)
NO.	Serial number assigned to each communication (001 to 999)
FILE NO.	File number for communication
DATE TIME	Start date and time for communication
DURATION	Communication period (indicated by a "minutes:seconds" form)
PGS	Number of pages for communication
TO	Communicated destination telephone number or name registered in the address book If the ◆ mark is indicated, the 2nd fax number registered in the address book has been used.
DEPT	Department code (If the department control is not performed, this field will become blank.)
MODE	Communication mode (2 digits) and transmission method (3 digits) or special communication mode (2 digits) If the ◆ mark is indicated, the 2nd line has been used. See the following table for the codes displayed in this field.
STATUS	Communication result and error code <ul style="list-style-type: none"> • OK: Completed successfully • NG: Completed abnormally • 4-digit error code: Communication failed For details about the error codes, see the reference below: Frequently Asked Questions - QUESTIONS FOR ERROR CODES - Questions for Error Codes - Error codes on transmission and reception

*1 This item is not available to some models.

Mode: 1. Communication mode

Display	Communication mode
EC	ECM communication
G3	G3 communication
ML	Email communication

Mode: 2. Transmission method

Display	Transmission speed (bps)	Resolution (pels/min)	Encoding systems
0	2,400	8 x 3.85	MH
1	4,800	8 x 7.7	MR
2	7,200	8 x 15.4	MMR
3	9,600		JBIG
4	12,000	16 x 15.4	
5	14,400		
6	V.34		
7			
8		300 dpi	
B		600 dpi	
D		150 dpi	
C		100 dpi	

Mode: 3. Special communication mode

Display	Special communication mode
P	Polling communication
SB	Mailbox communication
S R, R	Relay mailbox communication
SF, F	Forward mailbox communication
ML	Internet Fax communication
I	N/W-fax communication
O	Offramp Gateway communication

RECEPTION JOURNAL

Item name	Description
ROM version	Firmware version of the FAX Unit and the MFP. This appears at the upper right of the list.
TIME	Date and time of the output of the journal
FAX NO.1	Sender's fax number (line 1)
FAX NO.2 ^{*1}	Sender's fax number (line 2)
NAME	Registered terminal ID (line 1)
NAME (LINE2)	Registered terminal ID (line 2)
NO.	Serial number assigned to each communication (001 to 999)
FILE NO.	File number for communication
DATE TIME	Start date and time for communication
DURATION	Communication period (indicated by a "minutes:seconds" form)
PGS	Number of pages for communication
FROM	Communicated destination telephone number or name registered in the address book If the ◆ mark is indicated, the 2nd fax number registered in the address book has been used.
DEPT	Department code (If the department control is not performed, this field will become blank.)
MODE	Communication mode (2 digits) and transmission method (3 digits) or special communication mode (2 digits) If the ◆ mark is indicated, the 2nd line has been used. See the following table for the codes displayed in this field.
STATUS	Communication result and error code <ul style="list-style-type: none"> • OK: Completed successfully • NG: Completed abnormally • 4-digit error code: Communication failed For details about the error codes, see the reference below: Frequently Asked Questions - QUESTIONS FOR ERROR CODES - Questions for Error Codes - Error codes on transmission and reception

*1 This item is not available to some models.

Mode: 1. Communication mode

Display	Communication mode
EC	ECM communication
G3	G3 communication
ML	Email communication

Mode: 2. Transmission method

Display	Transmission speed (bps)	Resolution (pels/min)	Encoding systems
0	2,400	8 x 3.85	MH
1	4,800	8 x 7.7	MR
2	7,200	8 x 15.4	MMR
3	9,600		JBIG
4	12,000	16 x 15.4	
5	14,400		
6	V.34		
7			
8		300 dpi	
B		600 dpi	
D		150 dpi	
C		100 dpi	

Mode: 3. Special communication mode

Display	Special communication mode
P	Polling communication
SB	Mailbox communication
S R, R	Relay mailbox communication
SF, F	Forward mailbox communication
ML	Internet Fax communication
I	N/W-fax communication
O	Offramp Gateway communication

RESERVATION LIST

Item name	Description
TIME	Date and time of the output of the journal
FAX NO.1	Sender's fax number (line 1)
FAX NO.2 ^{*1}	Sender's fax number (line 2)
NAME	Registered terminal ID (line 1)
NAME (LINE2)	Registered terminal ID (line 2)
TX / RX	Reserved jobs for transmission/reception
RECOVERY TX	Reserved jobs which are made by recovery transmission
PC JOB	Reserved jobs which are made from a client computer
FILE NO.	File number for communication
DATE TIME	Start date and time for communication
FUNCTION	Type of transmission/reception
PGS	Number of pages for communication
TO	Communicated destination telephone number or name registered in the address book. If the  mark is indicated, the recipient has been specified with the direct entry method. If a G mark is indicated, the recipient has been specified with the group entry method.
DELAY TIME	Specified time for transmission (if registered)



*1 This item is not available to some models.

MAILBOX/RELAY BOX REPORT

Item name	Description
TIME	Date and time of the output of the journal
FAX NO.1	Sender's fax number (line 1)
FAX NO.2 ^{*1}	Sender's fax number (line 2)
NAME	Registered terminal ID (line 1)
NAME (LINE2)	Registered terminal ID (line 2)
MAIL BOX	History of confidential mailbox job and bulletin board mailbox job
RELAY	History of relay station mailbox job
FORWARD/INBOUND FAX(TSI)	History of forwarded jobs and inbound fax jobs (TSI)
BOX NO.	Box number of the communication destination
BOX TYPE	Type of communication
PGS	Number of pages for communication
FILE NO.	File number for communication
DATE TIME	Start date and time for communication
FROM	Originator of jobs
END STATION	ID code of the end station This field indicates an E-mail address by a 4-digit number and a group ID by a 3-digit number.
REPLY TO NUMBER	Telephone number of the reply destination
AGENT	Type of the agent
DESTINATION	Details of the forwarded recipient

*1 This item is not available to some models.

MEMORY TRANSMISSION REPORT

Item name	Description
TIME	Date and time of the output of the journal
FAX NO.1	Sender's fax number (line 1)
FAX NO.2 ^{*1}	Sender's fax number (line 2)
NAME	Registered terminal ID (line 1)
NAME (LINE2)	Registered terminal ID (line 2)
FILE NO.	File number for communication
DATE	Reception date and time for communication
TO	Communication destination If the  mark is indicated, the 2nd fax number registered in the address book has been used. If the  mark is indicated, the recipient has been specified with the direct entry method.
DOCUMENT PAGES	Number of original pages to be transmitted
START TIME	Start date and time for communication
END TIME	End date and time for communication
PAGES SENT	Number of pages for communication
STATUS	Communication result and error code <ul style="list-style-type: none"> • OK: Completed successfully • NG: Completed abnormally • 4-digit error code: Communication failed For details about the error codes, see the reference below: Frequently Asked Questions - QUESTIONS FOR ERROR CODES - Questions for Error Codes - Error codes on transmission and reception



*1 This item is not available to some models.

TRANSMISSION REPORT

Item name	Description
ROM version	Firmware version of the FAX Unit and the MFP. This appears at the upper right of the list.
TIME	Date and time of the output of the journal
FAX NO.1	Sender's fax number (line 1)
FAX NO.2 ^{*1}	Sender's fax number (line 2)
NAME	Registered terminal ID (line 1)
NAME (LINE2)	Registered terminal ID (line 2)
NO.	Serial number assigned to each communication (001 to 999)
FILE NO.	File number for communication
DATE TIME	Start date and time for communication
DURATION	Communication period (indicated by a "minutes:seconds" form)
PGS	Number of original pages transmitted
TO	Communicated destination telephone number or name registered in the address book. If the ◆ mark is indicated, the 2nd fax number registered in the address book has been used.
DEPT	Department code (If the department control is not performed, this field will become blank.)
MODE	Communication mode (2 digits) and transmission method (3 digits) or special communication mode (2 digits) If the ◆ mark is indicated, the 2nd line has been used. See the following table for the codes displayed in this field.
STATUS	Communication result and error code <ul style="list-style-type: none"> • OK: Completed successfully • NG: Completed abnormally • 4-digit error code: Communication failed For details about the error codes, see the reference below: Frequently Asked Questions - QUESTIONS FOR ERROR CODES - Questions for Error Codes - Error codes on transmission and reception

*1 This item is not available to some models.

MULTI TRANSMISSION REPORT

Item name	Description
TIME	Date and time of the output of the journal
FAX NO.1	Sender's fax number (line 1)
FAX NO.2 ^{*1}	Sender's fax number (line 2)
NAME	Registered terminal ID (line 1)
NAME (LINE2)	Registered terminal ID (line 2)
FILE NO.	File number for communication
DATE	Reception date and time for communication
START TIME	Start date and time for communication
END TIME	End date and time for communication
SUCCESSFUL	Recipient whose communication was completed successfully
UNSUCCESSFUL	Recipient whose communication was completed abnormally
ADDRESS BOOK	Communicated destination name registered in the address book. If the  mark is indicated, the 2nd fax number registered in the address book has been used.
FAX NUMBER	Registered name of communicated destination telephone number. If the  mark is indicated, the recipient has been specified with the direct entry method.
PAGES SENT	Number of pages for communication

*1 This item is not available to some models.

MULTI POLLING REPORT

Item name	Description
TIME	Date and time of the output of the journal
FAX NO.1	Sender's fax number (line 1)
FAX NO.2 ^{*1}	Sender's fax number (line 2)
NAME	Registered terminal ID (line 1)
NAME (LINE2)	Registered terminal ID (line 2)
FILE NO.	File number for communication
DATE	Reception date and time for communication
START TIME	Start date and time for communication
END TIME	End date and time for communication
SUCCESSFUL	Recipient whose communication was completed successfully
UNSUCCESSFUL	Recipient whose communication was completed abnormally
ADDRESS BOOK	Communicated destination name registered in the address book
FAX NUMBER	Registered name of communicated destination telephone number. If the  mark is indicated, the recipient has been specified with the direct entry method.

*1 This item is not available to some models.

RELAY TX ORIG. TERMINAL REPORT

Item name	Description
TIME	Date and time of the output of the journal
FAX NO.1	Sender's fax number (line 1)
FAX NO.2 ^{*1}	Sender's fax number (line 2)
NAME	Registered terminal ID (line 1)
NAME (LINE2)	Registered terminal ID (line 2)
FILE NO.	File number for communication
DATE	Reception date and time for communication
TO	Communicated destination telephone number or name registered in the address book. If the  mark is indicated, the recipient has been specified with the direct entry method.
RELAY BOX	Box number of the communication destination
DOCUMENT PAGES	Number of original pages to be transmitted
START TIME	Start date and time for communication
END TIME	End date and time for communication
PAGES SENT	Number of pages for communication
STATUS	Communication result <ul style="list-style-type: none">• OK: Completed successfully• NG: Completed abnormally

*1 This item is not available to some models.

RELAY TX RELAY STATION REPORT

Item name	Description
TIME	Date and time of the output of the journal
FAX NO.1	Sender's fax number (line 1)
FAX NO.2 ^{*1}	Sender's fax number (line 2)
NAME	Registered terminal ID (line 1)
NAME (LINE2)	Registered terminal ID (line 2)
FILE NO.	File number for communication
DATE	Reception date and time for communication
DOCUMENT PAGES	Number of original pages to be transmitted
FROM	Telephone number of the originator
START TIME	Start date and time for communication
END TIME	End date and time for communication
RELAY BOX	Box number of the communication destination
SUCCESSFUL	Recipient whose communication was completed successfully
UNSUCCESSFUL	Recipient whose communication was completed abnormally
GROUP NUMBER	Group number of the communicated destination
ADDRESS BOOK	Communicated destination name registered in the address book If the  mark is indicated, the 2nd fax number registered in the address book has been used.
PAGES SENT	Number of pages for communication

*1 This item is not available to some models.

RELAY TX END TERMINAL REPORT

Item name	Description
TIME	Date and time of the output of the journal
FAX NO.1	Sender's fax number (line 1)
FAX NO.2 ^{*1}	Sender's fax number (line 2)
NAME	Registered terminal ID (line 1)
NAME (LINE2)	Registered terminal ID (line 2)
FILE NO.	File number for communication
DATE	Reception date and time for communication
DOCUMENT PAGES	Number of original pages to be transmitted
FROM	Telephone number of the originator
START TIME	Start date and time for communication
END TIME	End date and time for communication
RELAY BOX	Box number of the communication destination
SUCCESSFUL	Recipient whose communication was completed successfully
UNSUCCESSFUL	Recipient whose communication was completed abnormally
GROUP NUMBER	Group number of the communicated destination
ADDRESS BOOK	Communicated destination name registered in the address book. If the ◆ mark is indicated, the 2nd fax number registered in the address book has been used.
PAGES SENT	Number of pages for communication

*1 This item is not available to some models.

RELAY STATION REPORT

Item name	Description
TIME	Date and time of the output of the journal
FAX NO.1	Sender's fax number (line 1)
FAX NO.2 ^{*1}	Sender's fax number (line 2)
NAME	Registered terminal ID (line 1)
NAME (LINE2)	Registered terminal ID (line 2)
FILE NO.	File number for communication
DATE	Reception date and time for communication
RELAY BOX	Box number of the communication destination
DOCUMENT PAGES	Number of original pages to be transmitted
FROM	Telephone number of the originator

*1 This item is not available to some models.

MAILBOX RECEPTION REPORT

Item name	Description
TIME	Date and time of the output of the journal
FAX NO.1	Sender's fax number (line 1)
FAX NO.2 ^{*1}	Sender's fax number (line 2)
NAME	Registered terminal ID (line 1)
NAME (LINE2)	Registered terminal ID (line 2)
FILE NO.	File number for communication
DATE	Reception date and time for communication
BOX NUMBER	Box number of the communication destination
BOX TYPE	Type of communication
DOCUMENT PAGES	Number of original pages to be transmitted
FROM	Telephone number of the originator

*1 This item is not available to some models.

INDEX

- A**
 - Add 103
 - Address Book..... 86, 87, 95
 - AddressBook Viewer 86, 87
 - Advanced 94
 - Advanced functions 115
- B**
 - [Body] 114
 - Bulletin board mailbox 53
- C**
 - Canceling reserved transmissions 47
 - Canceling the memory transmission job 45
 - Communication status log 43
 - Community Name 99
 - Confidential mailbox 53
 - Connecting cables..... 12
 - Control panel..... 10
 - Cover Sheet 96, 97
- D**
 - Delayed Fax 96, 105
 - Delete..... 103
 - Department Code..... 95
 - Department management..... 11
 - Details 101
 - [Device Settings] tab..... 100
 - Different width originals 17
 - Direct Tx..... 25
- E**
 - ECM for G3 25
 - Edit..... 96
 - E-mail..... 67, 68
 - E-mail address..... 67, 68
 - Enter the user credentials manually 101
 - Exposure..... 24, 114
 - External telephone..... 12, 34, 35, 39
- F**
 - Fax Function 101
 - Fax Number 95
 - Features
 - Internet Fax..... 112
 - File Format 96, 104
 - File formats 116
 - Fonts 97
 - Footer 98
 - From Name..... 25
 - FTP 71
 - FTPS..... 71
- H**
 - Header Text 98
 - Help..... 97
 - Hide Department Code 96
- I**
 - Initial setting 93
- Internet Fax..... 42, 68
 - precautions 113
 - receiving 116
 - sending 114
- Internet Fax Address 95
- Internet Fax Function 101
- ITU-T..... 26, 53
- J**
 - [Job Status] 10
- L**
 - [Layout] tab 94
 - Line Select 25
- M**
 - Mailbox Communication..... 26
 - Mailbox Transmission
 - creating the confidential or
 - bulletin board mailbox 59
 - creating/modifying a relay station mailbox 61
 - deleting a mailbox 63
 - deleting originals 56
 - printing originals..... 55
 - registering originals..... 54
 - retrieving originals..... 58
 - sending originals..... 57
 - Memory Tx 25
 - Message 98
- N**
 - N/W-Fax driver options 94
 - NetWareIP 72
 - NetWareIPX..... 72
 - Network Fax 42
 - Next original 21
- O**
 - OCR..... 96
 - Off-hook transmission 35
 - Offramp Gateway 68
 - On-hook transmission..... 34
 - Onramp Gateway 67
 - [Option]..... 26
 - Options 11
 - Orientation 94
 - Original
 - original scanning range 15
 - originals that can be sent 14
 - placing the original(s) on the original glass..... 15
 - Original Mode 24, 114
 - Original Size..... 22, 114
- P**
 - Paper
 - acceptable size of paper 36
 - default setting for Rx printing 36
 - paper priority when there is
 - no same size paper 37
 - Pausing transmission..... 47
 - [Preview] 32
 - Preview 97

Printing lists & reports	
automatically	77
manually	75
Priority Reserve	115
public network line	12
PWD.....	85

Q

Quality Tx.....	25
-----------------	----

R

Receiving	
Auto reception	39
Manual reception.....	39
Memory reception	40
Recipient	
Confirming/Deleting the recipients	31
searching for the recipient's fax number	28
specifying the recipient in the address book	28
Recipient's Information	98
Redial function	20
Reference Number	98
Relay station mailbox	53
Remove.....	95
Removing recipients	92
Reserved transmissions.....	42
Resolution	23, 95, 114
Restore Defaults.....	96, 98, 100

S

Save as File	96, 104
Send Cover Sheet Only	96
[Send] tab	95
Sender Information.....	98
Sending Network Faxes	81
Server Name	96, 103
Server Name List	103
SMB	72
SMTP server.....	68
SNMP Settings.....	96, 98
SNMP V1/V2	99
SNMP V3.....	99
Specifying Recipients of Network Faxes	84
SUB	85
SUB/PWD	95
[Subject]	114
Subject.....	98

T

To (recipient).....	95
Touch panel.....	10
Transmission conditions	
changing the settings for each page.....	26
Tx Type	25, 114

U

Update Automatically	100
Update Now.....	103
User Authentication	100
User management	11

V

Version	
N/W-Fax driver	101
SNMP	99

FC-2020AC/2520AC/2021AC/2521AC
FC-2525AC/3025AC/3525AC/4525AC/5525AC/6525AC
DP-2528A/3028A/3528A/4528A/5528A/6528A
FC-6526AC/6527AC/7527AC
DP-6529A/7529A/9029A

**MULTIFUNCTIONAL DIGITAL COLOR SYSTEMS /
MULTIFUNCTIONAL DIGITAL SYSTEMS**

Fax

e-STUDIO2020AC/2520AC/2021AC/2521AC

e-STUDIO2525AC/3025AC/3525AC/4525AC/5525AC/6525AC

e-STUDIO2528A/3028A/3528A/4528A/5528A/6528A

e-STUDIO6526AC/6527AC/7527AC

e-STUDIO6529A/7529A/9029A

Toshiba Tec Corporation

1-11-1, OSAKI, SHINAGAWA-KU, TOKYO, 141-8562, JAPAN

© 2021 - 2023 Toshiba Tec Corporation All rights reserved
Patent; <https://www.toshibatec.com/en/patent/>



OME210022B0
R210220X5802-TTEC
Ver02 F Issued in Oct. 2023